

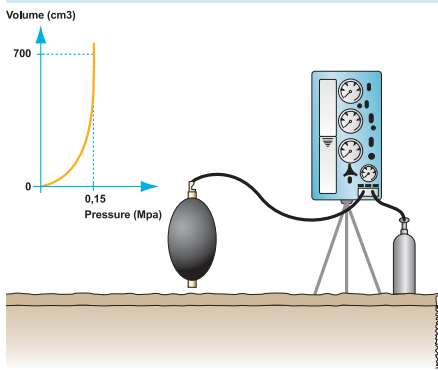

PRESSIONMÉTRIE PRESSUREMETER

Essai pressiométrique standard Standard pressiometric test

ÉTALONNAGE DE LA SONDE / CELL CALIBRATION



- Etant donné que l'étalonnage s'effectue en surface, la pression de gaz dans les cellules de garde doit être inférieure à la pression d'eau.
- Effectuer le test à l'air libre en suivant les instructions du paragraphe intitulé "Réalisation de l'essai pressiométrique". Utiliser des incréments de 25 ou 50 kPa (250 ou 500 millibars) pour les sondes caoutchouc ou les sondes à l'intérieur de tubes fendus.
- La courbe d'étalonnage est ainsi tracée et donne la perte de charge en fonction de l'augmentation de valeur.

- Since this calibration is carried out with the probe at ground level, gas circuit pressure in guard cells must be smaller than water circuit pressure.
- Perform a test with the probe in the open, following instructions chapter a "Carrying out pressiometric test". Use increments of 25 or 50 kPa (250 or 500 millibars) for probes with simple rubber cover or probes inside a slotted steel pipe respectively.
- The calibration curve is plotted as a typical test curve and gives the pressure loss against volume expansion.

CALIBRAGE DE L'APPAREILLAGE / SYSTEM CALIBRATION

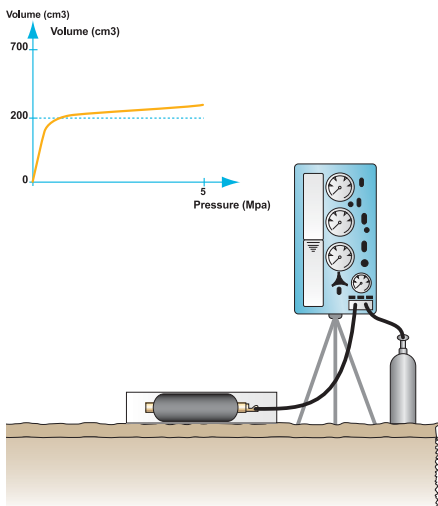

- Suivre les instructions de la norme, NF P 94-110-1, NF P 94-110-2 et ASTM D-4719-87.
- La légère augmentation de volume de la tubulure d'eau, due à l'augmentation de la pression, s'additionne à l'augmentation du volume de la cavité dans le sol, résultant dans des mesures légèrement trop fortes.
- Le principe de cet étalonnage réside dans la quantification de l'augmentation du volume de la tubulure lors de l'augmentation de la pression afin d'effectuer les corrections lors des essais.
- Cet étalonnage de la perte de volume est réalisé de la façon suivante. La sonde est introduite dans un tube en acier épais et rigide. La sonde est gonflée et la courbe de pression est tracée et enregistrée, indiquant clairement la perte de volume.

- Follow the instruction of the standard NF P 94-110-1, NF P 94-110-2 and ASTM D-4719-87.
- This calibration is necessary only when performing high pressure tests.
- The slight expansion of the whole water conduit, due to the pressure increase, is read in addition to the soil cavity volume increase, resulting into a slightly too large measure.
- The principle of this calibration is to measure the inflation of this conduit alone, at increasing pressures, in order to later reduce the test data.
- This "Volume Loss Test" is realised as follows : the probe is introduced in a heavy steel tube, which can be considered as being rigid. The probe is then inflated, and the volume versus pressure curve which is recorded will clearly indicate this volume loss.

RÉALISATION DE L'ESSAI PRESSIOMÉTRIQUE / CARRYING OUT A PRESSIOMETRIC TEST

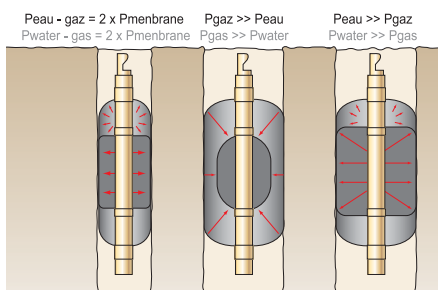

Réglage du différentiel de pression entre la cellule centrale et la cellule de garde.

- Etant donné que la dilatation de la cellule centrale nécessite une pression supérieure, il est important de s'assurer qu'il existe un différentiel de pression entre la cellule centrale et les cellules de garde, pour équilibrer la pression du terrain à l'interface avec le trou.
- Le différentiel de pression est habituellement considéré comme étant deux fois la pression

- nécessaire pour dilater la membrane de la cellule centrale à 700 cm³. Pour une membrane standard, cela signifie un différentiel de pression de 100kPa (1 bar). Etant donné l'effet du poids de la colonne d'eau dans la cellule centrale, il y aura, pour un test effectué à 10 mètres, un équilibre des pressions à l'interface avec la paroi du trou, lorsque la pression appliquée en surface est identique entre celle de l'eau et le circuit de gaz.
- Pour des tests à des profondeurs inférieures à 10 mètres, il faudra réduire la pression de gaz.
- Pour des tests à des profondeurs supérieures à 10 mètres, il faudra compenser l'augmentation de la pression de la colonne d'eau par une augmentation de la pression du circuit de gaz.

Setting up the pressure lag between the central cell and the guard cells.

- Since expansion of the central cell membrane requires additional pressure it is necessary to have a pressure lag between central

cell and end cells to balance the actual pressure at the borehole walls interface.

- This pressure lag is usually taken as twice the pressure necessary to expand the central cell membrane to 700 cm³. For standard membrane this means a pressure lag of 100 kPa (1 bar). Due to the effect of the head of water in the central cell, for a test at 10 m there is equilibrium between pressures at the borehole wall interface when the pressure applied at the elevation of the monitoring box is the same in the water and the gas circuit.
- For tests at depths shallower than 10 m, it is necessary to reduce the pressure in gas circuit.
- For tests at depths larger than 10 m it is necessary to compensate for increasing water head in the central cell by also increasing pressure in the air circuit.



Essai pressiométrique standard

Standard pressiometric test

PRESSIONMÉTRIE

PRESSUREMETER

Le tableau ci-dessous donne les valeurs typiques de différentiel de pression lorsque des membranes standard sont utilisées pour des tests jusqu'à 1 MPa (10 bars). Pour des pressions supérieures, 2 MPa (20 bars) par exemple, le poids de la colonne de gaz comprimé doit être pris en considération.

The table below gives typical values of pressure lag when standard central cell membranes are used, for tests up to 1 MPa (10 bars). For higher pressures, say from 2 MPa (20 bars) up, the weight of the compressed gas must be accounted for to assess the head of gas. This additional head given in the second table must be subtracted from the first.

Différence de profondeur entre l'appareil de mesure et la sonde / Difference in elevation between monitoring box and probe (meter)	Différentiel de pression entre le circuit d'air et le circuit d'eau mesuré en surface / Pressure lag between air circuit and water circuit measured on top	
	(kPa)	(bar)
1	-100	-1,0
2	-90	-0,9
3	-80	-0,8
4	-70	-0,7
5	-60	-0,6
6	-50	-0,5
7	-40	-0,4
8	-30	-0,3
9	-20	-0,2
10	-10	-0,1
11	0	0
12	+10	+0,1
13	+20	+0,2
20	+90	+0,9
25	+140	+1,4
30	+190	+1,9

PROFONDEUR (mètres) / DEPTH (meter)	PRESSION APPLIQUÉE SUR LA SONDE / PRESSURE APPLIED TO PROBE (MPa)					
	0	2	4	6	8	10
10	0	0	-0.1	-0.1	-0.1	-0.1
20	1.0	0.9	0.9	0.8	0.8	0.7
40	3.0	2.9	2.7	2.6	2.5	2.4
60	4.9	4.8	4.6	4.4	4.2	4.1
80	6.9	6.7	6.4	6.2	6.0	5.7
100	8.9	8.6	8.3	8.0	7.7	7.4



- Pour des membranes plus souples ou plus dures, d'autres tables doivent être calculées.
- For softer or stiffer membranes, other tables must be calculated.

LONGUEUR MAXIMALE DE LA PASSE DE FORAGE FAITE AVANT INTRODUCTION DE LA SONDE PRESSIOMÉTRIQUE / MAXIMUM DRILLING LENGTHS CUT PRIOR TO THE INTRODUCTION OF THE PRESSIOMETRIC CELL

Les longueurs maximales de forage pressiométrique à réaliser avant l'introduction de la sonde dépendent des propriétés des terrains, de l'existence d'une nappe et de la présence ou non d'un tubage. La longueur maximale de forage fait à l'avance doit respecter les règles regroupées dans le tableau ci-dessous.
(extrait de la norme NF P 94-110-1).

The maximum drilling lengths to be cut prior to the introduction of the drill depend on the soil properties, the existence of a layer and the presence or otherwise of a casing. The maximum length of prior drilling must comply with the rules set out below.
(extract of norm NF P 94-110-1).

NATURE DES TERRAINS / NATURE OF SOIL	LONGUEUR MAXIMALE DE FORAGE FAIT AVANT L'ESSAI (M) / MAXIMUM DRILLING LENGTH CARRIED OUT BEFORE TEST (M)
Vases et argiles molles / Sludge and Soft Clay	1** +
Argiles moyennement compactes / Medium-Compact Clay	3*
Argiles compactes, marnes raides / Compact Clay, Rough Marl	5
Limons / Silt :	
-au-dessus de la nappe / Above Layer	5
-sous la nappe / Below Layer	3*
Sables lâches / Loose Sand	
-au-dessus de la nappe / Above Layer	3
-sous la nappe / Below Layer	1** +
Sables moyennement compacts et compacts / Medium-Compact and Compact Sand	5
Sols grossiers : graviers, galets argiles à silex, etc. / Coarse Soils : Gravel, Pebbles, Flint-Clay, etc.	5
Roches altérées - Roches tendres / Altered Rocks - Tender Rocks	5

** Ou intervalle entre deux essais consécutifs / Or interval between two consecutive tests

+ Un tubage est recommandé au-delà de 10m de profondeur / Casing is recommended beyond a depth of 10m.



DATC

Des gaines de qualité

Quality cells

GAMME / RANGE



Gaine caoutchouc /
Rubber cell



Gaine toilée textile standard /
Standard textile cell



Gaine toilée textile haute pression / High pressure textile cell



Gaine toilée textile très haute pression / Very high pressure textile cell



Gaine toilée métallique /
Reinforced metallic cell

Inertie faible au gonflement / Nil inertia while inflating
Pas de déformation axiale / No axial strain





Présentation des différentes configurations

Presentation of different configurations

PRESSIONMÉTRIE PRESSUREMETER

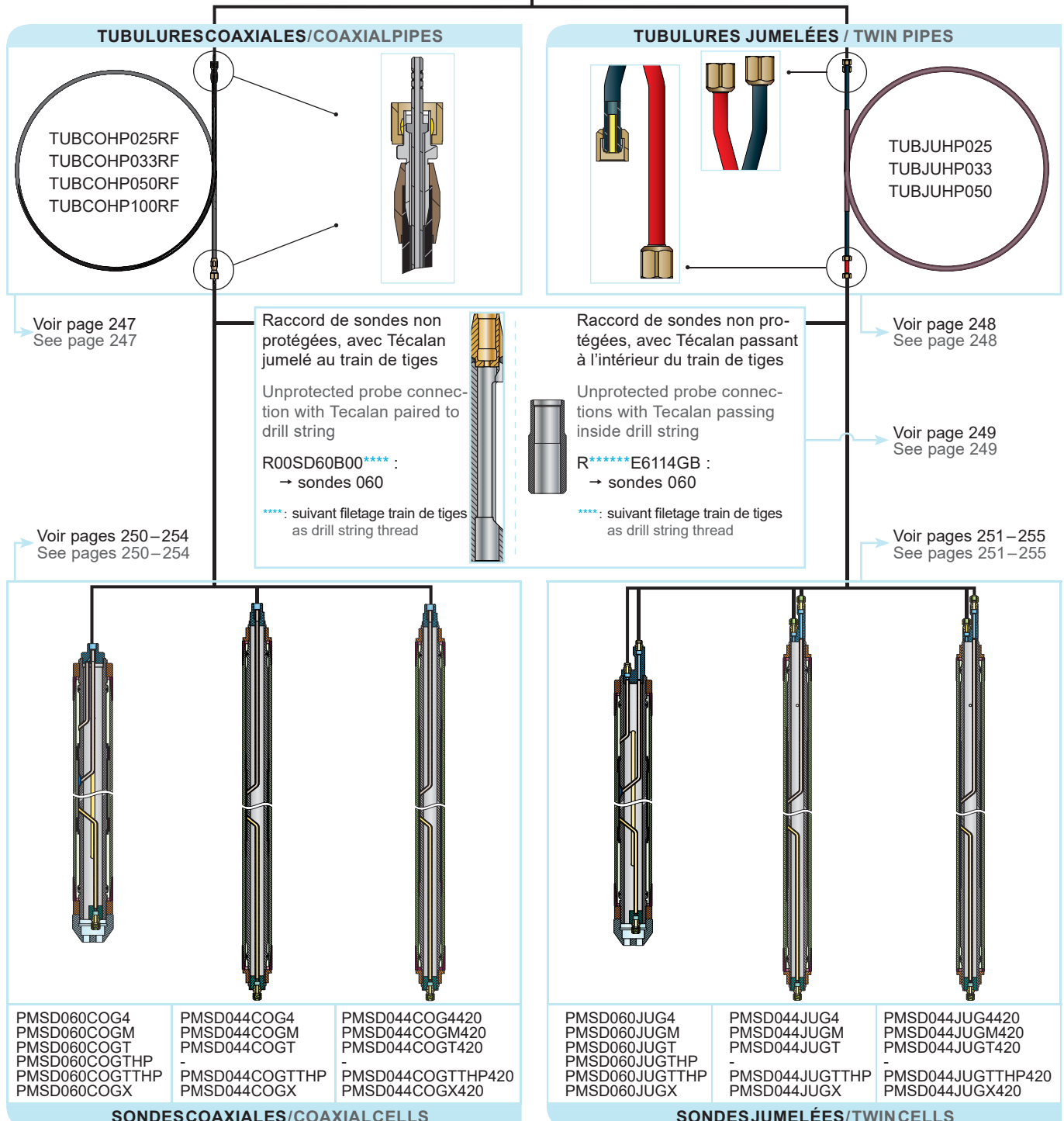
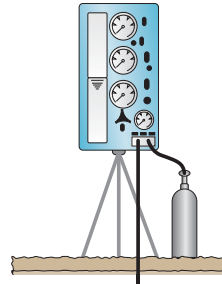

PRESSIONMÉTRIE

PRESSUREMETER

Contrôle mécanique et d'étanchéité des sondes

Mechanical & Watertightness Checking of Cell Sleeves

DATC atteste de la bonne qualité de ses sondes par contrôle unitaire. Ce contrôle est aussi bien mécanique que d'étanchéité.

DATC guarantees the quality of probes with case by case quality control. Both mechanical and watertightness tests are carried out.

Chaque sonde est frappée d'un numéro de série, une étiquette de contrôle qualité est apposée et la fiche de validation correspondante est archivée.

Each probe is stamped with a serial number, a quality control label is attached and the product's validation slip is archived.



Gravage du numéro de série propre à chaque sonde / Etching of serial number specific to each probe

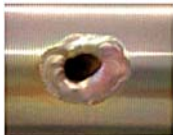

Vérification esthétique de la qualité de chaque soudure / Esthetic verification of each weld



Contrôle de chaque filetage à la jauge filetée / Check of each thread with threaded gauge



Vérification de l'alésage du logement des aiguilles sur sonde coaxiale / Verification of needle housing boring on coaxial probe

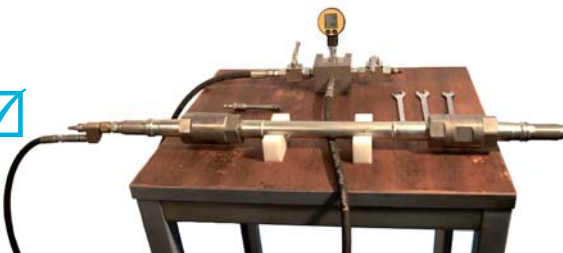

Test d'étanchéité de chaque cellule à 60 bars / Watertight test of each cell to 60 bars



Contrôle de montage du raccord hydropneumatique / Check of hydropneumatic connection



Traçabilité par étiquette de contrôle qualité / Traceability via quality control label



Tubulure coaxiale Coaxial Pipes

PRESSIONMÉTRIE PRESSUREMETER

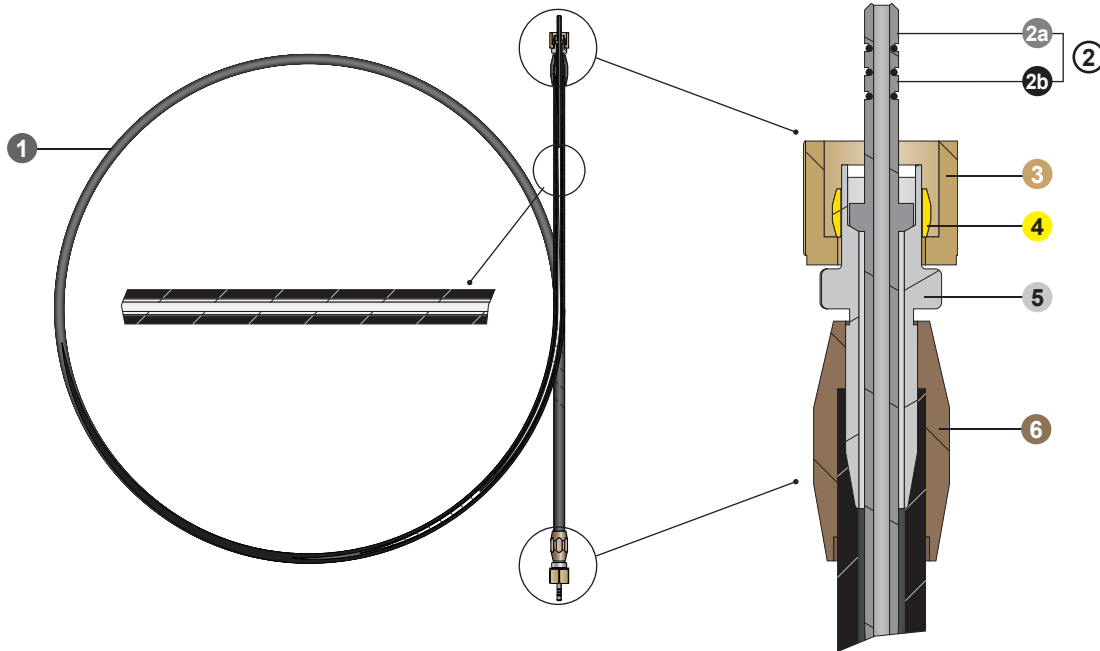

NOMENCLATURE / NOMENCLATURE

N° / Item	Longueur tubulure / Pipe Length				Description / Description
	25 m	33 m	50 m	100 m	
N° Article / Part No.					
-	TUBCOHP025RF	TUBCOHP033RF	TUBCOHP050RF	TUBCOHP100RF	
1	TUBCORL025PA	TUBCORL033PA	TUBCORL050PA	TUBCORL100PA	Tube polyamide avec Rilsan / Rilsan polyamide tube
2	TUBCOHP001	TUBCOHP001	TUBCOHP001	TUBCOHP001	Aiguille raccord avec joints / Needle connector with O Ring
2a	TUBCOHP001-1	TUBCOHP001-1	TUBCOHP001-1	TUBCOHP001-1	Aiguille raccord sans joints / Needle connector without O Ring
2b	JTH00390002300080	JTH00390002300080	JTH00390002300080	JTH00390002300080	Joint torique / O Ring
3	RAC0007E	RAC0007E	RAC0007E	RAC0007E	Ecrou de 16 / 16 Nut
4	RAC0007O	RAC0007O	RAC0007O	RAC0007O	Raccord olive / Pearl Fitting
5	RAC0005	RAC0005	RAC0005	RAC0005	Raccord côté sonde / Probe Side Fitting
6	RAC0006	RAC0006	RAC0006	RAC0006	Raccord côté tubulure / Pipe Side Fitting

ACCESSOIRES / ACCESSORIES

	Description / Description	N° Article / Part No.
	Bouchon de protection anti-âge des joints / Anti-aging protective cap for joints	RAC0017
	Raccord pour assembler 2 tubulures coaxiales / Fitting to connect two Coaxial Tubes	TUBCOHP000
	Prise coaxiale / Coaxial Fitting	RAC0014 <ul style="list-style-type: none"> 1 RAC0014-01 2 RAC0014-02 3 RAC0014-03



PRESSIONMÉTRIE PRESSUREMETER

Tubulure jumelée Twin Pipes

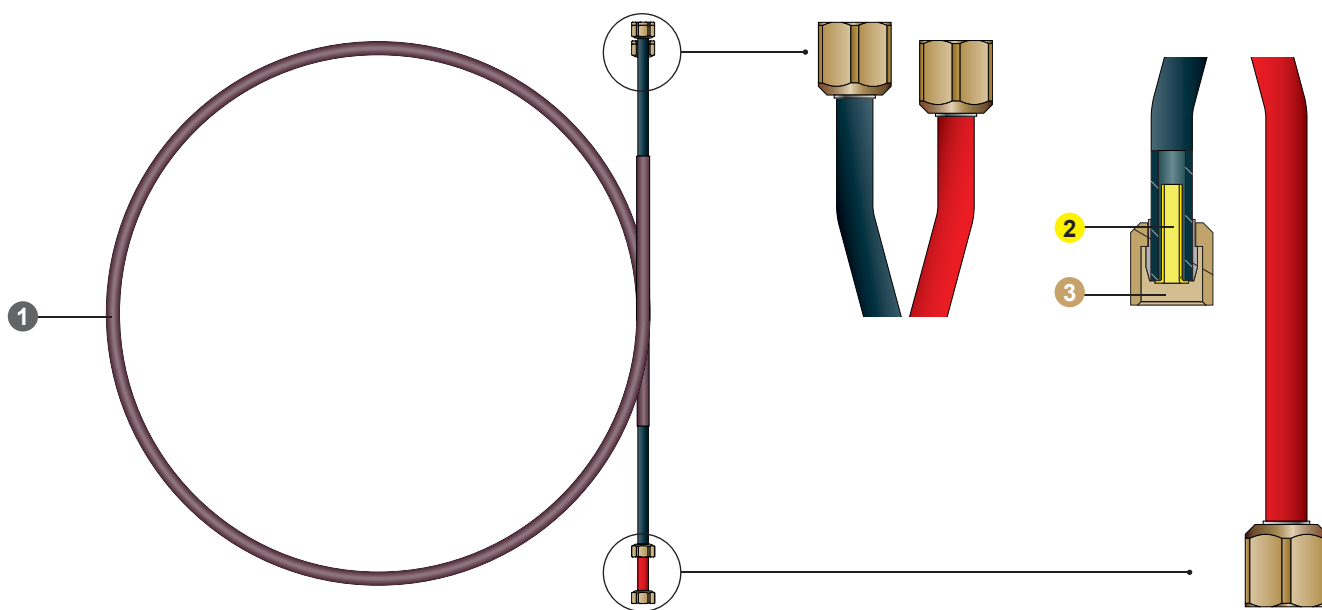

NOMENCLATURE / NOMENCLATURE

N° / Item	Longueur tubulure / Pipe Length				Description / Description
	25 m	33 m	50 m	100 m	
N° Article / Part No.					
-	TUBJUHP025	TUBJUHP033	TUBJUHP050	TUBJUHP100	
1	TUBJURL025PA	TUBJURL033PA	TUBJURL050PA	TUBJURL100PA	Tube polyamide avec Rilsan / Polyamide Tube with Rilsan
2	RAC0003	RAC0003	RAC0003	RAC0003	Fourrures de renforcement Ø 3 mm / Ø 3 mm Strengthening Sleeves
3	RAC0004	RAC0004	RAC0004	RAC0004	Ecrou de 6 mm avec olive incorporée / Nut 6 mm with Incorporated Pearl

ACCESSOIRES / ACCESSORIES

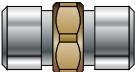
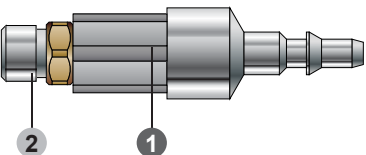
	Description / Description	N° Article / Part No.
	Raccord entre deux tubulures Fitting between 2 Pipes	RAC0018-1
	1+2 Prise jumelée complète Complete Twin Pipe Coupling	RAC0019
	1 Raccord pour connexion sur CPV Adapter for Connexion on CPV	RAC0016
	2 Raccord pour connexion tubulure Adapter for Twin Pipe Connexion	RAC0001-1





Raccords pour sondes Ø60

Ø60 Probe Couplings

PRESSIONMÉTRIE

PRESSUREMETER

SONDES 60 AVEC TUBULURE EXTÉRIEURE AU TRAIN DE TIGES / 60 PROBES WITH PIPE OUTSIDE DRILL STRING

Les sondes 60 peuvent être descendues dans le forage au moyen de raccords munis d'une lumière permettant à la tubulure coaxiale, ou jumelée, de rejoindre la sonde depuis l'extérieur du train de tiges. Le train de tiges peut être de différents modèles à la condition que le jumelage entre la tubulure et le train de tiges ne soit pas trop important pour abîmer prématurément la tubulure contre les parois du forage.

Type 60 probes may be lowered into the borehole using a split coupling. This allows the coaxial or twin tubing to reach the probe from outside the drill string. Different models of drill string can be used, as long as enough space is left for the tubing to pass without being prematurely spoiled against the borehole wall.

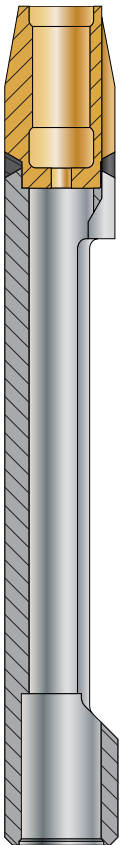

Sondes 60

N° Article / Part No.	Description / Description
R00SD60B00RD22B	Raccord pour sonde 60 x filetage tige 22 femelle / Split Coupling for Probe 60 x Rod 22 Box Thread
R00SD60B000PDBB	Raccord pour sonde 60 x filetage tige PDB femelle / Split Coupling for Probe 60 x Rod PDB Box Thread
R00SD60B000C42B	Raccord pour sonde 60 x filetage tige CR42 femelle / Split Coupling for Probe 60 x Rod CR42 Box Thread
R00SD60B000C50B	Raccord pour sonde 60 x filetage tige CR50 femelle / Split Coupling for Probe 60 x Rod CR50 Box Thread
R00SD60B000R28B	Raccord pour sonde 60 x filetage tige R28 femelle / Split Coupling for Probe 60 x Rod R28 Box Thread
R00SD60B000R32B	Raccord pour sonde 60 x filetage tige R32 femelle / Split Coupling for Probe 60 x Rod R32 Box Thread
R00SD60B000R38B	Raccord pour sonde 60 x filetage tige R38 femelle / Split Coupling for Probe 60 x Rod R38 Box Thread
R00SD60B0000AWB	Raccord pour sonde 60 x filetage tige AW femelle / Split Coupling for Probe 60 x Rod AW Box Thread
R00SD60B0000EWB	Raccord pour sonde 60 x filetage tige EW femelle / Split Coupling for Probe 60 x Rod EW Box Thread
R00SD60B000AWJB	Raccord pour sonde 60 x filetage tige AWJ femelle / Split Coupling for Probe 60 x Rod AWJ Box Thread
R00SD60B000BWJB	Raccord pour sonde 60 x filetage tige BWJ femelle / Split Coupling for Probe 60 x Rod BWJ Box Thread

Pour d'autres filetages, nous consulter / For other threads, consult us.

SONDES 60 AVEC TUBULURE À L'INTÉRIEUR DU TRAIN DE TIGES / 60 PROBES WITH PIPE INSIDE DRILL STRING

La descente des sondes 60 dans le forage peut également se faire au moyen de raccords non fendus : la tubulure coaxiale ou jumelée reste dans ce cas protégée à l'intérieur du train de tiges. Ce train de tiges doit obligatoirement avoir un diamètre intérieur capable d'accueillir la tubulure et ses raccords (Ø 22 mini). Cette condition limite le type de tiges utilisables.

The 60 probe can also be send down the borehole using a non-split couplings. In this case the coaxial or twin tubing remains protected inside the drill string. The drill string must have an internal diameter capable of receiving the tubing and fittings (Ø 22 min). This condition limits the type of rods to be used.

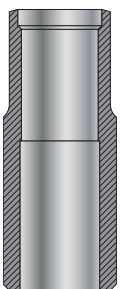

Sondes 60

N° Article / Part No.	Description / Description
RD20C42BE6114GB	Raccord non fendu pour sonde 60 x filetage CR42 femelle / Not Split Coupling for Probe 60 x CR42 Box Thread
RE00C50BE6114GB	Raccord non fendu pour sonde 60 x filetage CR50 femelle / Not Split Coupling for Probe 60 x CR50 Box Thread
RF00C60BE6114GB	Raccord non fendu pour sonde 60 x filetage CR60 femelle / Not Split Coupling for Probe 60 x CR60 Box Thread

Pour d'autres filetages, nous consulter / For other threads, consult us.



PRESSIONMÉTRIE PRESSUREMETER

Sonde de 60 mm COAXIALE COAXIAL 60 mm Probe

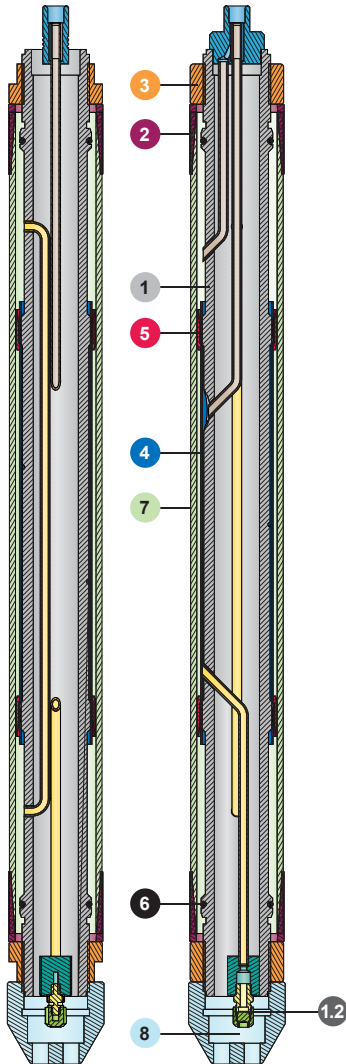

N° / Item	N° Article / Part No.	Description / Description
1	PMSD0600OUT	Arracheur & clé pour bague gaine / Sleeve ring stripper with wrench
2	PMSD0600OUT1	Clé à oeil pour écrou de gaine / Ring spanner for sleeve nut
3	PMSD0600OUT2	Arracheur de bague de membrane / Membrane ring stripper
4	PMSD0600OUT3	Support sonde pour maintenance / Maintenance jig for probe



N° / Item	N° Article / Part No.	Description / Description
1 → 7	PMSD060COG4	Sonde coaxiale 60 avec gaine caoutchouc 4 mm / Coaxial Probe 60 with 4 mm Rubber Sleeve
1 → 7	PMSD060COGT	Sonde coaxiale 60 avec gaine textile STANDARD / Coaxial Probe 60 with STANDARD Textile Sleeve
1 → 7	PMSD060COGTHP	Sonde coaxiale 60 avec gaine textile HAUTE PRESSION / Coaxial Probe 60 with HIGH PRESSURE Textile Sleeve
1 → 7	PMSD060COGTTHP	Sonde coaxiale 60 avec gaine textile TRES HAUTE PRESSION / Coaxial Probe 60 with VERY HIGH PRESSURE Textile Sleeve
1 → 7	PMSD060COGX	Sonde coaxiale 60 avec gaine toilée métallique / Coaxial Probe 60 with Metallic Reinforced Sleeve

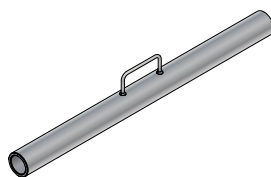

N° Article / Part No.	Description / Description
PMSD065TUCA	Tube de calibrage Ø intérieur 65 mm / Calibration Tube Inner Ø 65 mm

N° / Item	N° Article / Part No.	Description / Description	Qté / Qty
1	PMSD060COBK	Corps de sonde nu / Blank Probe Body	1
1.2	RAC0000	Raccord de purge (bouchon fermé) / Stopped Drain Plug	1
2	PMSD0600001	Bague de gaine / Ring Sleeve	2
3	PMSD0600002	Ecrou en bronze / Bronze Nut	2
4	PMSD060B275R	Membrane ronde / Rounded Membrane	1
5	PMSD0600003	Bague de membrane / Membrane Ring	2
6	JTH04500038000350	Joint torique / O Ring	2
7	PMSD0604510	Gaine caoutchouc épaisseur 4 mm / Rubber Sleeve Thickness 4 mm	1
7	PMSD060T510	Gaine toilée textile Standard / Standard Textile Sleeve	1
7	PMSD060T510HP	Gaine toilée textile Haute Pression / High Pression Textile Sleeve	1
7	PMSD060T510THP	Gaine toilée textile Très Haute Pression / Very High Pression Textile Sleeve	1
7	PMSD060X510	Gaine toilée métallique / Metallic Reinforced Sleeve	1
8	PMSD0600004	Sabot de sonde* / Probe Shoe*	1

* Le sabot n'est pas vendu avec la sonde / Shoe is not sold with probe



Sonde de 60 mm jumelée TWIN 60 mm Probe

PRESSIOMÉTRIE PRESSUREMETER

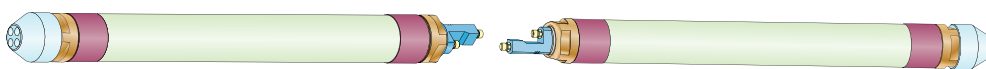
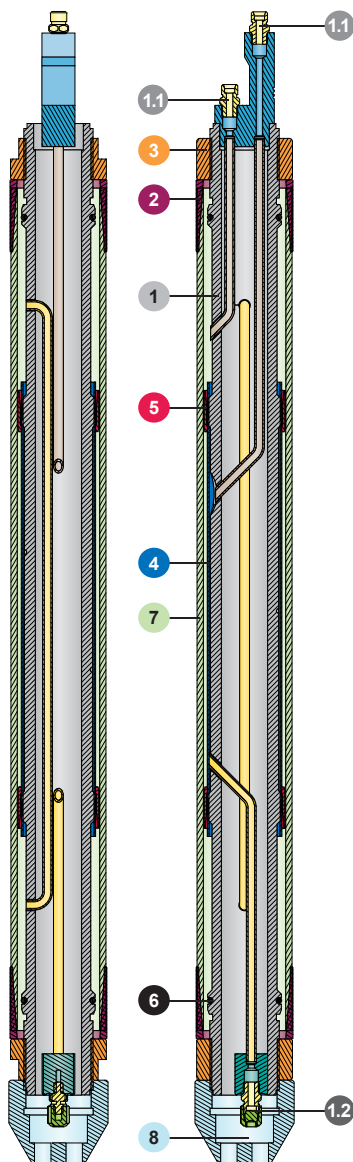

N° / Item	N° Article / Part No.	Description / Description
1	PMSD0600OUT	Arracheur & clé pour bague gaine / Sleeve ring stripper with wrench
2	PMSD0600OUT1	Clé à oeil pour écrou de gaine / Ring spanner for sleeve nut
3	PMSD0600OUT2	Arracheur de bague de membrane / Membrane ring stripper
4	PMSD0600OUT3	Support sonde pour maintenance / Maintenance jig for probe

N° / Item	N° Article / Part No.	Description / Description
1 → 7	PMSD060JUG4	Sonde jumelée 60 avec gaine caoutchouc 4 mm / Twin Probe 60 with 4 mm Rubber Sleeve
1 → 7	PMSD060JUGT	Sonde jumelée 60 avec gaine textile STANDARD / Twin Probe 60 with STANDARD Textile Sleeve
1 → 7	PMSD060JUGTHP	Sonde jumelée 60 avec gaine textile HAUTE PRESSION / Twin Probe 60 with HIGH PRESSURE Textile Sleeve
1 → 7	PMSD060JUGTTHP	Sonde jumelée 60 avec gaine textile TRES HAUTE PRESSION / Twin Probe 60 with VERY HIGH PRESSURE Textile Sleeve
1 → 7	PMSD060JUGX	Sonde jumelée 60 avec gaine toilée métallique / Twin Probe 60 with Metallic Reinforced Sleeve

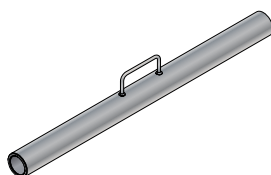

N° Article / Part No.	Description / Description
PMSD065TUCA	Tube de calibrage Ø intérieur 65 mm / Calibration Tube Inner Ø 65 mm

N° / Item	N° Article / Part No.	Description / Description	Qté / Qty
1	PMSD060JUBK	Corps de sonde nu / Blank Probe Body	1
1.1	RAC0001	Raccord pour tubulure (bouchon ouvert) / Open Drain Plug	2
1.2	RAC0000	Raccord de purge (bouchon fermé) / Stopped Drain Plug	1
2	PMSD0600001	Bague de gaine / Ring Sleeve	2
3	PMSD0600002	Écrou en bronze / Bronze Nut	2
4	PMSD060B275R	Membrane ronde / Rounded Membrane	1
5	PMSD0600003	Bague de membrane / Membrane Ring	2
6	JTH04500038000350	Joint torique / O Ring	2
7	PMSD0604510	Gaine caoutchouc épaisseur 4 mm / Rubber Sleeve Thickness 4 mm	1
7	PMSD060T510	Gaine toilée textile Standard / Standard Textile Sleeve	1
7	PMSD060T510HP	Gaine toilée textile Haute Pression / High Pression Textile Sleeve	1
7	PMSD060T510THP	Gaine toilée textile Très Haute Pression / Very High Pression Textile Sleeve	1
7	PMSD060X510	Gaine toilée métallique / Metallic Reinforced Sleeve	1
8	PMSD0600004	Sabot de sonde* / Probe Shoe*	1

* Le sabot n'est pas vendu avec la sonde / Shoe is not sold with probe



PRESSIONMÉTRIE

PRESSUREMETER

Sonde de 44 mm longue avec membrane courte COAXIALE

Long COAXIAL 44 mm Probe with short membrane

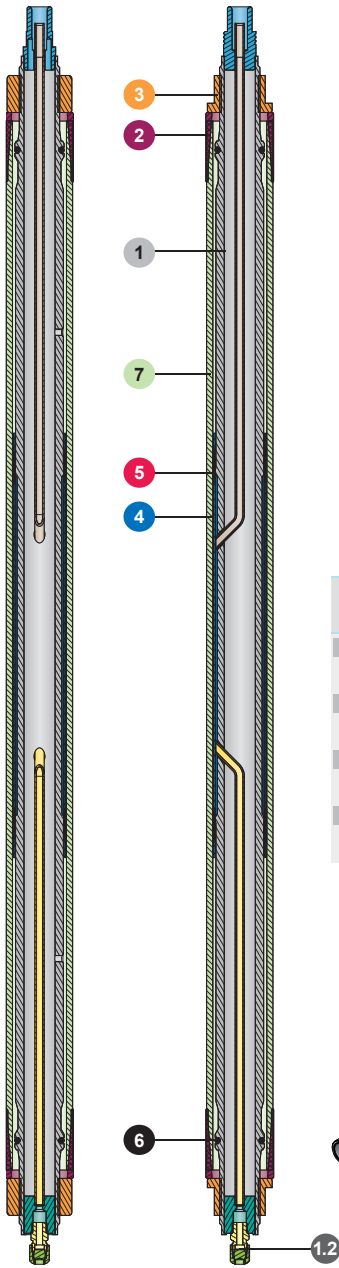

N° / Item	N° Article / Part No.	Description / Description
1	PMSD0440OUT	Arracheur & clé pour bague gaine / Sleeve ring stripper with wrench
2	PMSD0440UT1	Clé à oeil pour écrou de gaine / Ring spanner for sleeve nut
3	PMSD0440OUT2	Arracheur de bague de membrane / Membrane ring stripper
4	PMSD0440UT3	Support sonde pour maintenance / Maintenance jig for probe

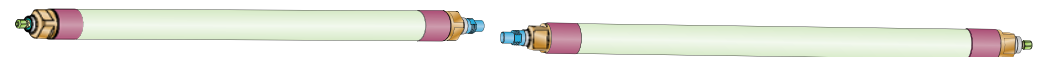

N° / Item	N° Article / Part No.	Description / Description
1 → 7	PMSD044COG4	Sonde coaxiale 44 avec gaine caoutchouc 4 mm / Coaxial Probe 44 with 4 mm Rubber Sleeve
1 → 7	PMSD044COGT	Sonde coaxiale 44 avec gaine textile STANDARD / Coaxial Probe 44 with STANDARD Textile Sleeve
1 → 7	PMSD044COGTHP	Sonde coaxiale 44 avec gaine textile TRES HAUTE PRESSION / Coaxial Probe 44 with VERY HIGH PRESSURE Textile Sleeve
1 → 7	PMSD044COGX	Sonde coaxiale 44 avec gaine toilée métallique / Coaxial Probe 44 with Metallic Reinforced Sleeve

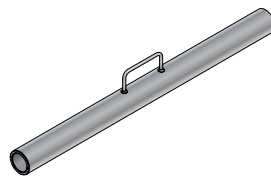

N° Article / Part No.	Description / Description
PMSD060TUCA	Tube de calibrage Ø intérieur 60 mm / Calibration Tube Inner Ø 60 mm
PMSD065TUCA	Tube de calibrage Ø intérieur 65 mm / Calibration Tube Inner Ø 65 mm

N° / Item	N° Article / Part No.	Description / Description	Qté / Qty
1	PMSD044COBK	Corps de sonde nu / Blank Probe Body	1
1.2	RAC0000	Raccord de purge (bouchon fermé) / Stopped Drain Plug	1
2	PMSD0440001	Bague de gaine / Ring Sleeve	2
3	PMSD0440002	Écrou en bronze / Bronze Nut	2
4	PMSD044B270R	Membrane ronde / Rounded Membrane	1
5	PMSD0440003	Bague de membrane / Membrane Ring	2
6	JTH03210025000355	Joint torique / O Ring	2
7	PMSD0444680	Gaine caoutchouc épaisseur 4 mm / Rubber Sleeve Thickness 4 mm	1
7	PMSD044T680	Gaine toilée textile Standard / Standard Textile Sleeve	1
7	PMSD044T680THP	Gaine toilée textile Très Haute Pression / Very High Pression Textile Sleeve	1
7	PMSD044X680	Gaine toilée métallique / Metallic Reinforced Sleeve	1



Sonde de 44 mm longue avec membrane courte jumelée

Long TWIN 44 mm Probe with short membrane

PRESSIOMÉTRIE PRESSUREMETER

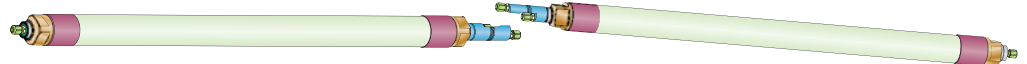
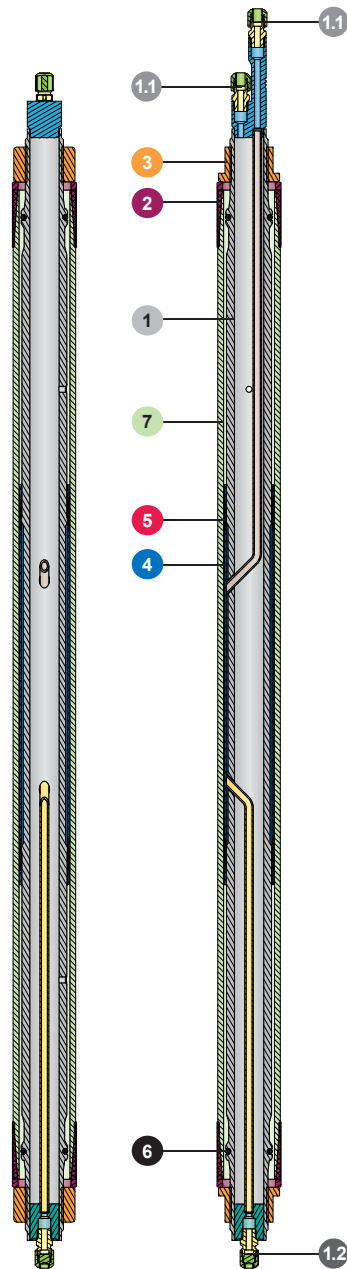

N° / Item	N° Article / Part No.	Description / Description
1	PMSD0440OUT	Arracheur & clé pour bague gaine / Sleeve ring stripper with wrench
2	PMSD0440OUT1	Clé à oeil pour écrou de gaine / Ring spanner for sleeve nut
3	PMSD0440OUT2	Arracheur de bague de membrane / Membrane ring stripper
4	PMSD0440OUT3	Support sonde pour maintenance / Maintenance jig for probe

N° / Item	N° Article / Part No.	Description / Description
1 → 7	PMSD044JUG4	Sonde jumelée 44 avec gaine caoutchouc 4 mm / Twin Probe 44 with 4 mm Rubber Sleeve
1 → 7	PMSD044JUGT	Sonde jumelée 44 avec gaine textile STANDARD / Twin Probe 44 with STANDARD Textile Sleeve
1 → 7	PMSD044JUGTTHP	Sonde jumelée 44 avec gaine textile TRES HAUTE PRESSION / Twin Probe 44 with VERY HIGH PRESSURE Textile Sleeve
1 → 7	PMSD044JUGX	Sonde jumelée 44 avec gaine toilée métallique / Twin Probe 44 with Metallic Reinforced Sleeve

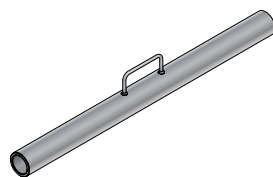

N° Article / Part No.	Description / Description
PMSD060TUCA	Tube de calibrage Ø intérieur 60 mm / Calibration Tube Inner Ø 60 mm
PMSD065TUCA	Tube de calibrage Ø intérieur 65 mm / Calibration Tube Inner Ø 65 mm

N° / Item	N° Article / Part No.	Description / Description	Qté / Qty
1	PMSD044JUBK	Corps de sonde nu / Blank Probe Body	1
1.1	RAC0001	Raccord pour tubulure (bouchon ouvert) / Open Drain Plug	2
1.2	RAC0000	Raccord de purge (bouchon fermé) / Stopped Drain Plug	1
2	PMSD0440001	Bague de gaine / Ring Sleeve	2
3	PMSD0440002	Écrou en bronze / Bronze Nut	2
4	PMSD044B270R	Membrane ronde / Rounded Membrane	1
5	PMSD0440003	Bague de membrane / Membrane Ring	2
6	JTH03210025000355	Joint torique / O Ring	2
7	PMSD0444680	Gaine caoutchouc épaisseur 4 mm / Rubber Sleeve Thickness 4 mm	1
7	PMSD044T680	Gaine toilée textile Standard / Standard Textile Sleeve	1
7	PMSD044T680THP	Gaine toilée textile Très Haute Pression / Very High Pression Textile Sleeve	1
7	PMSD044X680	Gaine toilée métallique / Metallic Reinforced Sleeve	1



PRESSIONNÉTRIE

PRESSUREMETER

Sonde de 44 mm longue avec membrane longue COAXIALE

Long COAXIAL 44 mm Probe with long membrane

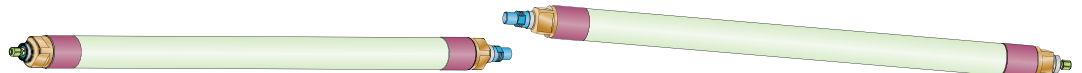
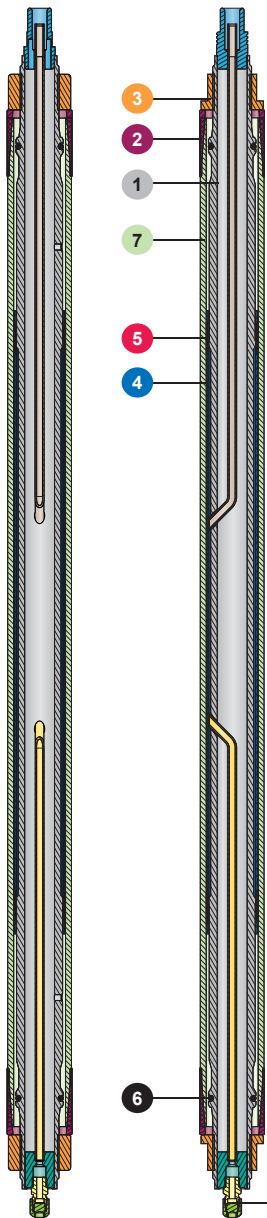

N° / Item	N° Article / Part No.	Description / Description
1	PMSD0440OUT	Arracheur & clé pour bague gaine / Sleeve ring stripper with wrench
2	PMSD0440OUT1	Clé à oeil pour écrou de gaine / Ring spanner for sleeve nut
3	PMSD0440OUT2	Arracheur de bague de membrane / Membrane ring stripper
4	PMSD0440OUT3	Support sonde pour maintenance / Maintenance jig for probe
1 → 7	PMSD044COG4420	Sonde coaxiale 44 avec gaine caoutchouc 4 mm / Coaxial Probe 44 with 4 mm Rubber Sleeve
1 → 7	PMSD044COGT420	Sonde coaxiale 44 avec gaine textile STANDARD / Coaxial Probe 44 with STANDARD Textile Sleeve
1 → 7	PMSD044COGT420THP	Sonde coaxiale 44 avec gaine textile TRES HAUTE PRESSION / Coaxial Probe 44 with VERY HIGH PRESSION Textile Sleeve
1 → 7	PMSD044COGX420	Sonde coaxiale 44 avec gaine toilée métallique / Coaxial Probe 44 with Metallic Reinforced Sleeve

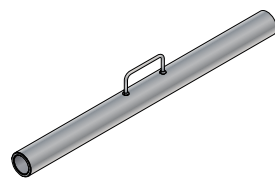

N° Article / Part No.	Description / Description
PMSD060TUCA	Tube de calibrage Ø intérieur 60 mm / Calibration Tube Inner Ø 60 mm
PMSD065TUCA	Tube de calibrage Ø intérieur 65 mm / Calibration Tube Inner Ø 65 mm

N° / Item	N° Article / Part No.	Description / Description	Qté / Qty
1	PMSD044COBK420	Corps de sonde nu / Blank Probe Body	1
1.2	RAC0000	Raccord de purge (bouchon fermé) / Stopped Drain Plug	1
2	PMSD0440001	Bague de gaine / Ring Sleeve	2
3	PMSD0440002	Écrou en bronze / Bronze Nut	2
4	PMSD044B420R	Membrane ronde / Rounded Membrane	1
5	PMSD0440003	Bague de membrane / Membrane Ring	2
6	JTH03210025000355	Joint torique / O Ring	2
7	PMSD0444680	Gaine caoutchouc épaisseur 4 mm / Rubber Sleeve Thickness 4 mm	1
7	PMSD044T680	Gaine toilée textile Standard / Standard Textile Sleeve	1
7	PMSD044T680THP	Gaine toilée textile Très Haute Pression / Very High Pression Textile Sleeve	1
7	PMSD044X680	Gaine toilée métallique / Metallic Reinforced Sleeve	1



Sonde de 44 mm longue avec membrane longue jumelée

Long TWIN 44 mm Probe with long membrane

PRESSIONNÉTRIE PRESSUREMETER

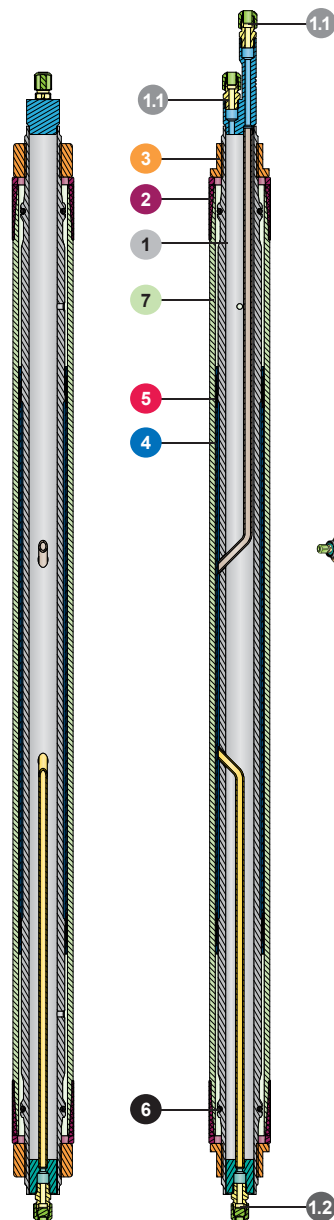

N° / Item	N° Article / Part No.	Description / Description
1	PMSD0440OUT	Arracheur & clé pour bague gaine / Sleeve ring stripper with wrench
2	PMSD0440OUT1	Clé à oeil pour écrou de gaine / Ring spanner for sleeve nut
3	PMSD0440OUT2	Arracheur de bague de membrane / Membrane ring stripper
4	PMSD0440OUT3	Support sonde pour maintenance / Maintenance jig for probe

N° / Item	N° Article / Part No.	Description / Description
1 → 7	PMSD044JUG4420	Sonde jumelée 44 avec gaine caoutchouc 4 mm / Twin Probe 44 with 4 mm Rubber Sleeve
1 → 7	PMSD044JUGT420	Sonde jumelée 44 avec gaine textile STANDARD / Twin Probe 44 with STANDARD Textile Sleeve
1 → 7	PMSD044JUGT420THP	Sonde jumelée 44 avec gaine textile TRES HAUTE PRESSION / Twin Probe 44 with VERY HIGH PRESSURE Textile Sleeve
1 → 7	PMSD044JUGX420	Sonde jumelée 44 avec gaine toilée métallique / Twin Probe 44 with Metallic Reinforced Sleeve

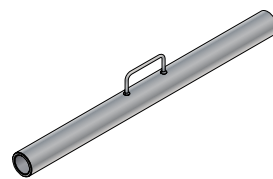

N° Article / Part No.	Description / Description
PMSD060TUCA	Tube de calibrage Ø intérieur 60 mm / Calibration Tube Inner Ø 60 mm
PMSD065TUCA	Tube de calibrage Ø intérieur 65 mm / Calibration Tube Inner Ø 65 mm

N° / Item	N° Article / Part No.	Description / Description	Qté / Qty
1	PMSD044JUBK420	Corps de sonde nu / Blank Probe Body	1
1.1	RAC0001	Raccord pour tubulure (bouchon ouvert) / Open Drain Plug	2
1.2	RAC0000	Raccord de purge (bouchon fermé) / Stopped Drain Plug	1
2	PMSD0440001	Bague de gaine / Ring Sleeve	2
3	PMSD0440002	Écrou en bronze / Bronze Nut	2
4	PMSD044B420R	Membrane ronde / Rounded Membrane	1
5	PMSD0440003	Bague de membrane / Membrane Ring	2
6	JTH03210025000355	Joint torique / O Ring	2
7	PMSD0444680	Gaine caoutchouc épaisseur 4 mm / Rubber Sleeve Thickness 4 mm	1
7	PMSD044T680	Gaine toilée textile Standard / Standard Textile Sleeve	1
7	PMSD044T680THP	Gaine toilée textile Très Haute Pression / Very High Pression Textile Sleeve	1
7	PMSD044X680	Gaine toilée métallique / Metallic Reinforced Sleeve	1



PRESSIONMÉTRIE PRESSUREMETER

Tube fendu 63 mm standard 63 mm Standard Tube



TUBE FENDU 63 MM STANDARD / 63 MM STANDARD TUBE

N° / Item	N° Article / Part No.	Description / Description
1	RFSP063PE00C50B	Raccord fendu tube 63 droite mâle x CR50 droite fem / Split Coupling 63 Tube RH Pin x CR50 RH Box
1	RFSP063PF00C60B	Raccord fendu tube 63 droite mâle x CR60 droite fem / Split Coupling 63 Tube RH Pin x CR60 RH Box
1	RFSP063PD40R32B	Raccord fendu tube 63 droite mâle x R32 gauche fem / Split Coupling 63 Tube RH Pin x R32 LH Box
1	RFSP063PE50R38B	Raccord fendu tube 63 droite mâle x R38 gauche fem / Split Coupling 63 Tube RH Pin x R38 LH Box
2	TUST063RH100M	Tube de battage 63 droite 1.00 m / Drive Tube 63 RH 1.00 m
2	TUST063RH120M	Tube de battage 63 droite 1.20 m / Drive Tube 63 RH 1.20 m
2	TUST063RH150M	Tube de battage 63 droite 1.50 m / Drive Tube 63 RH 1.50 m
2	TUST063RH183M	Tube de battage 63 droite 1.83 m / Drive Tube 63 RH 1.83 m
3	TFST063RH	Tube fendu 63 droite / Slotted Tube 63 RH
3	TFST063RHE	Tube fendu 63 droite ELITE / Slotted Tube 63 RH ELITE
4	TUST063PTE0LGRH	Pointe 63 droite longue / Cone 63 RH Long
5	TUST063PTE0CTRH	Pointe 63 droite courte / Cone 63 RH Short
6	TUST063SABRTRRH	Sabot 63 droite à rétreint / Shoe 63 RH
7	TU00000PTEAM180	Amortisseur polyuréthane / Polyurethane Shock Absorber
8	TUST063PTERDL	Rondelle pleine (sauf pour pointe courte) / Plain Washer (not for short cone)
9	TUST063PTERDC	Rondelle creuse / Open Washer
1	LFSP063PE00C50B	Raccord fendu tube 63 gauche mâle x CR50 droite fem / Split Coupling 63 Tube LH Pin x CR50 RH Box
1	LFSP063PF00C60B	Raccord fendu tube 63 gauche mâle x CR60 droite fem / Split Coupling 63 Tube LH Pin x CR60 RH Box
1	LFSP063PC20R32B	Raccord fendu tube 63 gauche mâle x R32 gauche fem / Split Coupling 63 Tube LH Pin x R32 LH Box
1	LFSP063PC90R38B	Raccord fendu tube 63 gauche mâle x R38 gauche fem / Split Coupling 63 Tube LH Pin x R38 LH Box
2	TUST063LH100M	Tube de battage 63 gauche 1.00 m / Tube 63 LH 1.00 m
2	TUST063LH120M	Tube de battage 63 gauche 1.20 m / Tube 63 LH 1.20 m
2	TUST063LH150M	Tube de battage 63 gauche 1.50 m / Tube 63 LH 1.50 m
2	TUST063LH183M	Tube de battage 63 gauche 1.83 m / Tube 63 LH 1.83 m
3	TFST063LH	Tube fendu 63 gauche / Slotted Tube 63 LH
3	TFST063LHE	Tube fendu 63 gauche ELITE / Slotted Tube 63 LH ELITE
4	TUST063PTE0LGLH	Pointe 63 gauche longue / Cone 63 LH Long
5	TUST063PTE0CTLH	Pointe 63 gauche courte / Cone 63 LH Short
6	TUST063SABRTRLH	Sabot 63 gauche à rétreint / Shoe 63 LH

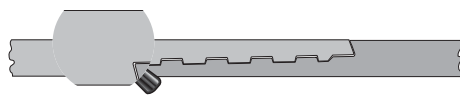
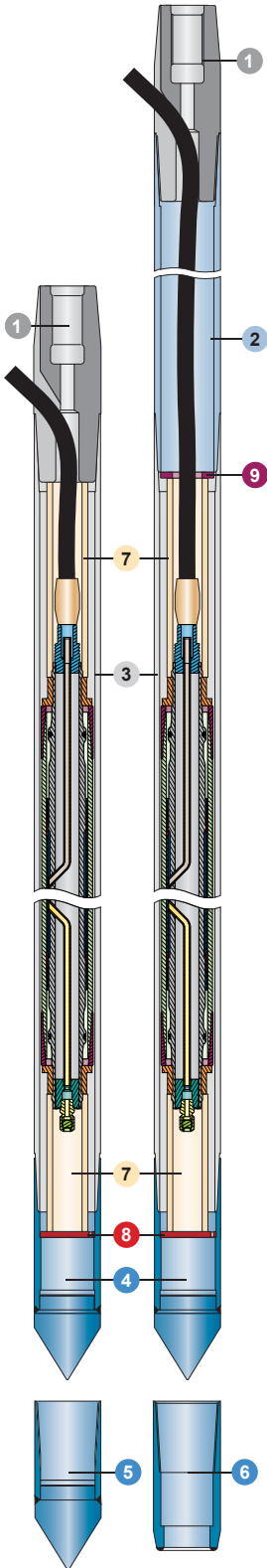

Filetage standard / Standard Thread

DATC fabrique sur demande tout type de diamètre de tube fendu.
DATC can manufacture any slotted tube diameter on request.





Tube fendu 63 mm renforcé 63 mm Reinforced Tube

PRESSIOMÉTRIE PRESSUREMETER

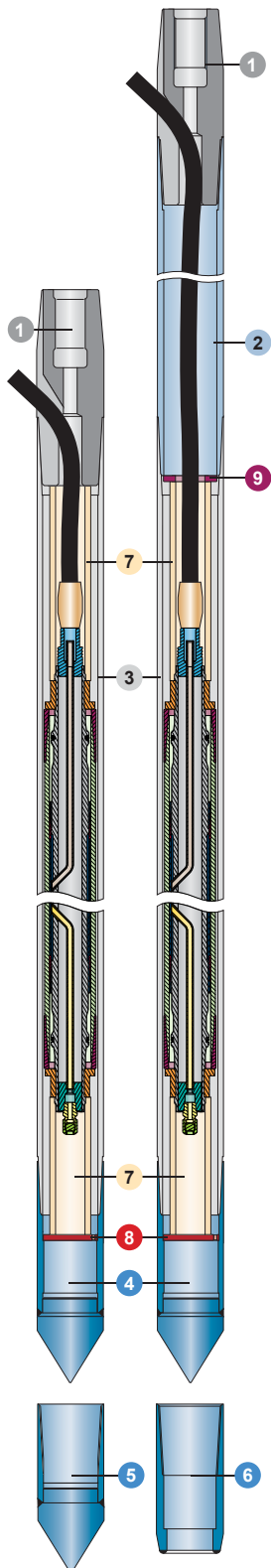

TUBE FENDU 63 MM RENFORCÉ / 63 MM REINFORCED TUBE



N° / Item	N° Article / Part No.	Description / Description
1	RFSR063PE00C50B	Raccord fendu tube 63 droite mâle x CR50 droite fem / Split Coupling 63 Tube RH Pin x CR50 RH Box
1	RFSR063PF00C60B	Raccord fendu tube 63 droite mâle x CR60 droite fem / Split Coupling 63 Tube RH Pin x CR60 RH Box
1	RFSR063PD40R32B	Raccord fendu tube 63 droite mâle x R32 gauche fem / Split Coupling 63 Tube RH Pin x R32 LH Box
1	RFSR063PE50R38B	Raccord fendu tube 63 droite mâle x R38 gauche fem / Split Coupling 63 Tube RH Pin x R38 LH Box
2	TURF063RH100M	Tube de battage 63 droite 1.00 m / Drive Tube 63 RH 1.00 m
2	TURF063RH120M	Tube de battage 63 droite 1.20 m / Drive Tube 63 RH 1.20 m
2	TURF063RH150M	Tube de battage 63 droite 1.50 m / Drive Tube 63 RH 1.50 m
2	TURF063RH183M	Tube de battage 63 droite 1.83 m / Drive Tube 63 RH 1.83 m
3	TFRF063RH	Tube fendu 63 droite / Slotted Tube 63 RH
3	TFRF063RHE	Tube fendu 63 droite ELITE / Slotted Tube 63 RH ELITE
4	TUST063PTE0LGRH	Pointe 63 droite longue / Cone 63 RH Long
5	TUST063PTE0CTRH	Pointe 63 droite courte / Cone 63 RH Short
6	TUST063SABRTRRH	Sabot 63 droite à rétreint / Shoe 63 RH
7	TU00000PTEAM180	Amortisseur polyuréthane / Polyurethane Shock Absorber
8	TUST063PTERDL	Rondelle pleine (sauf pour pointe courte) / Plain Washer (not for short cone)
9	TURF063PTERDC	Rondelle creuse / Open Washer
1	LFSR063PE00C50B	Raccord fendu tube 63 gauche mâle x CR50 droite fem / Split Coupling 63 Tube LH Pin x CR50 RH Box
1	LFSR063PF00C60B	Raccord fendu tube 63 gauche mâle x CR60 droite fem / Split Coupling 63 Tube LH Pin x CR60 RH Box
1	LFSR063PC20R32B	Raccord fendu tube 63 gauche mâle x R32 gauche fem / Split Coupling 63 Tube LH Pin x R32 LH Box
1	LFSR063PC90R38B	Raccord fendu tube 63 gauche mâle x R38 gauche fem / Split Coupling 63 Tube LH Pin x R38 LH Box
2	TURF063LH100M	Tube de battage 63 gauche 1.00 m / Tube 63 LH 1.00 m
2	TURF063LH120M	Tube de battage 63 gauche 1.20 m / Tube 63 LH 1.20 m
2	TURF063LH150M	Tube de battage 63 gauche 1.50 m / Tube 63 LH 1.50 m
2	TURF063LH183M	Tube de battage 63 gauche 1.83 m / Tube 63 LH 1.83 m
3	TFRF063LH	Tube fendu 63 gauche / Slotted Tube 63 LH
3	TFRF063LHE	Tube fendu 63 gauche ELITE / Slotted Tube 63 LH ELITE
4	TUST063PTE0LGLH	Pointe 63 gauche longue / Cone 63 LH Long
5	TUST063PTE0CTLH	Pointe 63 gauche courte / Cone 63 LH Short
6	TUST063SABRTRLH	Sabot 63 gauche à rétreint / Shoe 63 LH

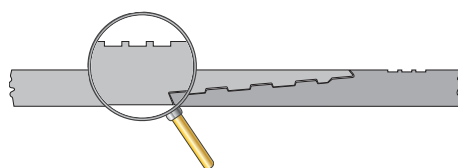

Filetage renforcé / Reinforced Thread

DATC fabrique sur demande tout type de diamètre de tube fendu.
DATC can manufacture any slotted tube diameter on request.



PRESSIONNÉTRIE PRESSUREMETER

Tube fendu 56 mm standard 56 mm Standard Tube

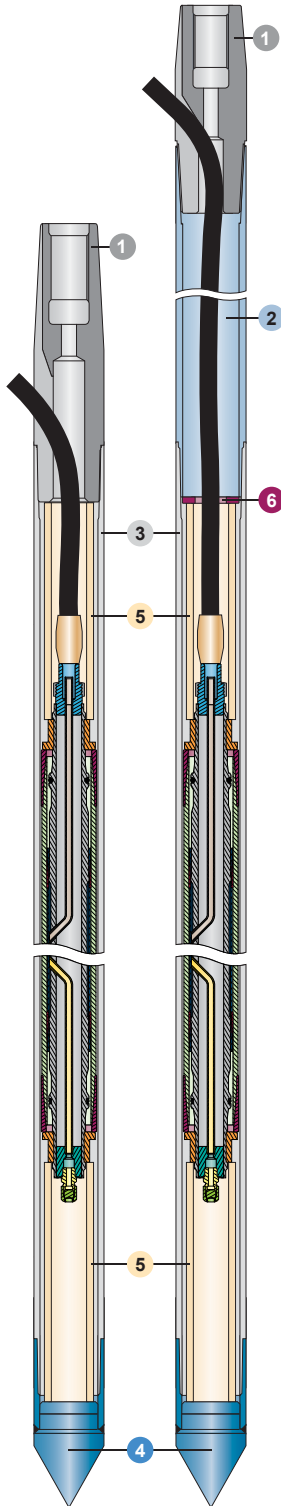

TUBE FENDU 56 MM STANDARD / 56 MM STANDARD TUBE



N° / Item	N° Article / Part No.	Description / Description
1	RFSP056PE00C50B	Raccord fendu tube 56 droite mâle x CR50 droite fem / Split Coupling 56 Tube RH Pin x CR50 RH Box
1	RFSP056PD40R32B	Raccord fendu tube 56 droite mâle x R32 gauche fem / Split Coupling 56 Tube RH Pin x R32 LH Box
1	RFSP056PE50R38B	Raccord fendu tube 56 droite mâle x R38 gauche fem / Split Coupling 56 Tube RH Pin x R38 LH Box
2	TUST056RH100M	Tube de battage 56 droite 1.00 m / Drive Tube 56 RH 1.00 m
2	TUST056RH120M	Tube de battage 56 droite 1.20 m / Drive Tube 56 RH 1.20 m
2	TUST056RH150M	Tube de battage 56 droite 1.50 m / Drive Tube 56 RH 1.50 m
2	TUST056RH183M	Tube de battage 56 droite 1.83 m / Drive Tube 56 RH 1.83 m
3	TFST056RH	Tube fendu 56 droite / Slotted Tube 56 RH
4	TUST056PTE000RH	Pointe 56 droite courte / Cone 56 RH Short
5	TU00000PTEAM180	Amortisseur polyuréthane / Polyurethane Shock Absorber
6	TUST056PTERDC	Rondelle creuse / Open Washer
1	LFSP056PE00C50B	Raccord fendu tube 56 gauche mâle x CR50 droite fem / Split Coupling 56 Tube RH Pin x CR50 RH Box
1	LFSP056PC20R32B	Raccord fendu tube 56 gauche mâle x R32 gauche fem / Split Coupling 56 Tube LH Pin x R32 LH Box
1	LFSP056PC90R38B	Raccord fendu tube 56 gauche mâle x R38 gauche fem / Split Coupling 56 Tube LH Pin x R38 LH Box
2	TUST056LH100M	Tube de battage 56 gauche 1.00 m / Drive Tube 56 LH 1.00 m
2	TUST056LH120M	Tube de battage 56 gauche 1.20 m / Drive Tube 56 LH 1.20 m
2	TUST056LH150M	Tube de battage 56 gauche 1.50 m / Drive Tube 56 LH 1.50 m
2	TUST056LH183M	Tube de battage 56 gauche 1.83 m / Drive Tube 56 LH 1.83 m
3	TFST056LH	Tube fendu 56 gauche / Slotted Tube 56 LH
4	TUST056PTE000LH	Pointe 56 gauche courte / Cone 56 LH Short

DATC fabrique sur demande tout type de diamètre de tube fendu.
DATC can manufacture any slotted tube diameter on request.





Tube fendu 56 mm renforcé 56 mm Reinforced Tube

PRESSIOMÉTRIE PRESSUREMETER

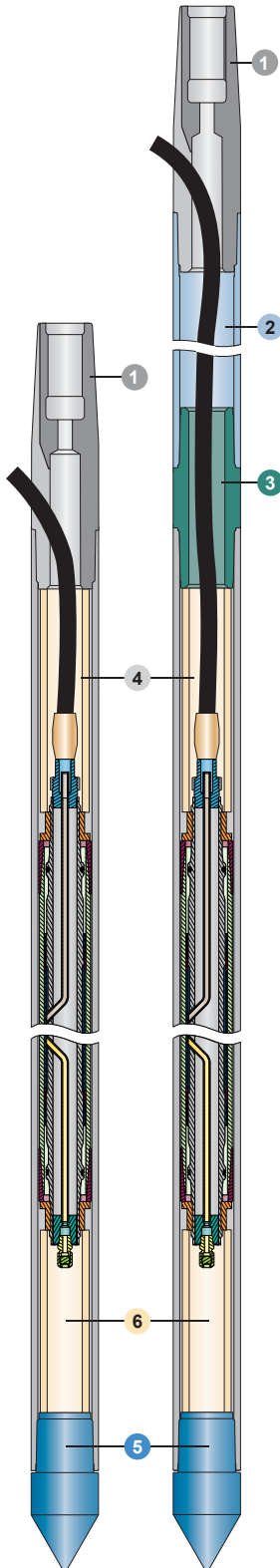

TUBE FENDU 56 MM RENFORCÉ / 56 MM REINFORCED TUBE



N° / Item	N° Article / Part No.	Description / Description
1	RFSR056PE00C50B	Raccord fendu tube 56 droite mâle x CR50 droite fem / Split Coupling 56 Tube RH Pin x CR50 RH Box
1	RFSR056PD40R32B	Raccord fendu tube 56 droite mâle x R32 gauche fem / Split Coupling 56 Tube RH Pin x R32 LH Box
1	RFSR056PE50R38B	Raccord fendu tube 56 droite mâle x R38 gauche fem / Split Coupling 56 Tube RH Pin x R38 LH Box
2+3	TURF056RH100M	Tube de battage 56 droite 1.00 m avec raccord / Drive Tube 56 RH 1.00 m with Coupling
2+3	TURF056RH120M	Tube de battage 56 droite 1.20 m avec raccord / Drive Tube 56 RH 1.20 m with Coupling
2+3	TURF056RH150M	Tube de battage 56 droite 1.50 m avec raccord / Drive Tube 56 RH 1.50 m with Coupling
2+3	TURF056RH183M	Tube de battage 56 droite 1.83 m avec raccord / Drive Tube 56 RH 1.83 m with Coupling
3	TURF056RHCPGL	Raccord droite / Coupling RH
4	TFRF056RH	Tube fendu 56 droite / Slotted Tube 56 RH
5	TURF056PTE000RH	Pointe 56 droite courte / Cone 56 RH Short
6	TU00000PTEAM180	Amortisseur polyuréthane / Polyurethane Shock Absorber
1	LFSR056PE00C50B	Raccord fendu tube 56 gauche mâle x CR50 droite fem / Split Coupling 56 Tube RH Pin x CR50 RH Box
1	LFSR056PC20R32B	Raccord fendu tube 56 gauche mâle x R32 gauche fem / Split Coupling 56 Tube LH Pin x R32 LH Box
1	LFSR056PC90R38B	Raccord fendu tube 56 gauche mâle x R38 gauche fem / Split Coupling 56 Tube LH Pin x R38 LH Box
2+3	TURF056LH100M	Tube de battage 56 gauche 1.00 m avec raccord / Tube 56 LH 1.00 m with Coupling
2+3	TURF056LH120M	Tube de battage 56 gauche 1.20 m avec raccord / Tube 56 LH 1.20 m with Coupling
2+3	TURF056LH150M	Tube de battage 56 gauche 1.50 m avec raccord / Tube 56 LH 1.50 m with Coupling
2+3	TURF056LH183M	Tube de battage 56 gauche 1.83 m avec raccord / Tube 56 LH 1.83 m with Coupling
3	TURF056LHCPGL	Raccord gauche / Coupling LH
4	TFRF056LH	Tube fendu 56 gauche / Slotted Tube 56 LH
5	TURF056PTE000LH	Pointe 56 gauche courte / Cone 56 LH Short

DATC fabrique sur demande tout type de diamètre de tube fendu.
DATC can manufacture any slotted tube diameter on request.



FORAGE PRESSIO **PRESSIO DRILLING**

Présentation des différentes méthodes de forage pour les essais pressiométriques

Presentation of different drilling methods for pressuremeter tests

Forage à la Tarière / Auger Drilling



Voir page 261
See page 261

Forage en rotation (Tricône ou trilame) /
Rotary Drilling (Rock Bit or Drag Bit)



Voir page 262
See page 262

Forage à l'outil en rotoperçussion R32 ou R38 /
Drilling with rotary percussion tool R32 or R38



Voir pages 263-264
See pages 263-264

Forage au marteau fond de trou / Down the Hole Drilling



Voir pages 265-266
See pages 265-266

Forage au carottier double T2-66 ou au carottier échantillonneur STS 63 /
Drilling with Double Tube Core Barrel T2-66 or Solid Tube Sampler STS 63



Voir pages 267-268
See pages 267-268

Forage par méthode de tubage à l'avancement /
Overburden drilling method



Voir page 269
See page 269

Forage à la tarière à main / Hand Auger Drilling



Voir page 270
See page 270



Forage Ø 64-66 mm Tarières

Drilling Ø 64-66 mm – Augers



FORAGE PRESSIO PRESSIO DRILLING

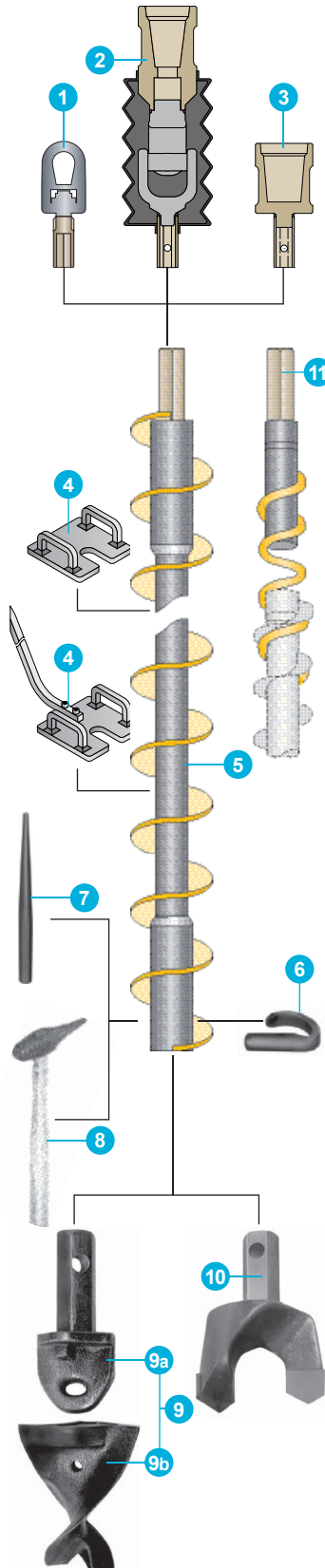

		Avec goupille With U Pin	
		25 mm	32 mm
N° / Item	Description / Description	N° Article / Part No.	N° Article / Part No.
	Ø Trou / Hole Ø : 64 mm Ø Tarière / Auger Flight Ø : 61±2 mm Pas tarière / Auger Pitch : 55±3 mm Epaisseur spire / Flight thickness : 8 mm Ø âme / Center Shaft Ø : →		
1	Touret de levage rotatif 25 kN / Hoisting Swivel - 25 kN	HS025H021B	HS025H021B
2	Cardan soudé avec soufflet / Gimbals with Protective Bellows Emmanchement Hexagonal 21 Fem. / Hex 21 Shank x R66 Fem / Box x H55 Fem. / Box x 2 3/8" API Reg Fem / Box x 2 3/8" API If Fem / Box	CARD090H021B0R66B CARD090H021B0H55B CARD090H021B238RB CARD090H021B238IB	CARD090H021B0R66B CARD090H021B0H55B CARD090H021B238RB CARD090H021B238IB
3	Raccord soudé / Welded Coupling Emmanchement Hexagonal 21 Fem. / Hex 21 Shank x R66 Fem / Box x H55 Fem. / Box x 2 3/8" API Reg Fem / Box x 2 3/8" API If Fem / Box	RC2H021BI00R66B RC2H021BI00H55B RC2H021BI0238RB RC2H021BI0238IB	RC2H021BI00R66B RC2H021BI00H55B RC2H021BI0238RB RC2H021BI0238IB
4	Fourchette / Auger Holder	AUG025FOUM	AUG032FOUM
4	Fourchette avec manche / Auger Holder with Handle	AUG025FOUMAN	AUG032FOUMAN
5	Tarière / Auger - L = 0.75 m Tarière / Auger - L = 1.00 m Tarière / Auger - L = 1.50 m	AUG063RH075H021 AUG063RH075H021GM025 AUG063RH100H021 AUG063RH100H021GM025 AUG063RH150H021 AUG063RH150H021GM025	AUG063RH075H021GM AUG063RH100H021GM AUG063RH150H021GM
6	Goupille / U Pin	UPIN021	UPIN021
7	Chasse goupille / Pinch Bar	AUGCG	AUGCG
8	Marteau chasse goupille / Pointed Hammer	AUGMG	AUGMG
9	Outil queue de carpe / Fishtail Bit	AUG063FSTCH021	AUG063FSTCH021GM
9a	Entraîneur / Shank	AUG000ST01H021	AUG000ST01H021GM
9b	Lame acier / Fishtail Steel Blade Lame rechargée carbure / Hard Faced Blade Lame inserts carbure / Fishtail Blade with TC Inserts	AUG063FST01 AUG063FST01HR AUG063FST01HRC	AUG063FST01 AUG063FST01HR AUG063FST01HRC
10	Outil 2 doigts / 2-Wing Prong Mining Bits	AUG0632WBTC021	AUG0632WBTC021GM
10	Outil 2 doigts renforcé / TC Reinforced 2-Wing Prong Mining Bits	AUG0632WBTC021HR	AUG0632WBTC021HRGM
11	Repêche tarière / Auger Retriever	AUG063RTA	AUG063RTA



FORAGE PRESSIO PRESSIO DRILLING



Forage Ø 64-66 mm
Rotation
Drilling Ø 64-66 mm - Rotary

FORAGE DESTRUCTIF / ROTARY DRILLING

N° / N° Article / Item Part No.	Description / Description.
1a ROD0C50RH050MBB ROD0C50RH075MBB ROD0C50RH100MBB ROD0C50RH150MBB ROD0C50RH200MBB ROD0C50RH300MBB	Tige CR50 fem x fem / CR50 Drill Rod Box x Box Lg 0.50 m Tige CR50 fem x fem / CR50 Drill Rod Box x Box Lg 0.75 m Tige CR50 fem x fem / CR50 Drill Rod Box x Box Lg 1.00 m Tige CR50 fem x fem / CR50 Drill Rod Box x Box Lg 1.50 m Tige CR50 fem x fem / CR50 Drill Rod Box x Box Lg 2.00 m Tige CR50 fem x fem / CR50 Drill Rod Box x Box Lg 3.00 m
1b ROD0C50RHCPGL	Raccord CR50 mâle x mâle / Coupling CR50 Pin x Pin
2 RODFW60RH050M RODFW60RH075M RODFW60RH100M RODFW60RH150M RODFW60RH200M RODFW60RH300M	Tige CR60 / CR60 Drill Rod Lg 0.50 m Tige CR60 / CR60 Drill Rod Lg 0.75 m Tige CR60 / CR60 Drill Rod Lg 1.00 m Tige CR60 / CR60 Drill Rod Lg 1.50 m Tige CR60 / CR60 Drill Rod Lg 2.00 m Tige CR60 / CR60 Drill Rod Lg 3.00 m
2 RODFBWJRH050M RODFBWJRH075M RODFBWJRH100M RODFBWJRH150M RODFBWJRH200M RODFBWJRH300M	Tige BWJ / BWJ Drill Rod Lg 0.50 m Tige BWJ / BWJ Drill Rod Lg 0.75 m Tige BWJ / BWJ Drill Rod Lg 1.00 m Tige BWJ / BWJ Drill Rod Lg 1.50 m Tige BWJ / BWJ Drill Rod Lg 2.00 m Tige BWJ / BWJ Drill Rod Lg 3.00 m
2 RODFNWJRH050M RODFNWJRH075M RODFNWJRH100M RODFNWJRH150M RODFNWJRH200M RODFNWJRH300M	Tige NWJ / NWJ Drill Rod Lg 0.50 m Tige NWJ / NWJ Drill Rod Lg 0.75 m Tige NWJ / NWJ Drill Rod Lg 1.00 m Tige NWJ / NWJ Drill Rod Lg 1.50 m Tige NWJ / NWJ Drill Rod Lg 2.00 m Tige NWJ / NWJ Drill Rod Lg 3.00 m
3 RE00C50BE7NRODB RF00C60BE7NRODB RE50BWJBE7NRODB RF70NWJBE7NRODB	Raccord CR50 Fem / Coupling CR50 Box x N-Rod Fem / Box Raccord CR60 Fem / Coupling CR60 Box x N-Rod Fem / Box Raccord BWJ Fem / Coupling BWJ Box x N-Rod Fem / Box Raccord NWJ Fem / Coupling CR60 Box x N-Rod Fem / Box
4 RBMTXD3020102NRODP* RBTCXT4020102NRODP** DB3W020102NRODP RBMTXD3020508NRODP* RBTCXT4020508NRODP** DB3W020508NRODP	Tricône à dents / Milledtooth Rockbit N-Rod Ø 64 mm 2 1/2" Tricône à picots / TCI Rockbit N-Rod Ø 64 mm 2 1/2" Trilames / Dragbits N-Rod Ø 64 mm 2 1/2" Tricône à dents / Milledtooth Rockbit N-Rod Ø 66 mm 2 5/8" Tricône à picots / TCI Rockbit N-Rod Ø 66 mm 2 5/8" Trilames / Dragbits N-Rod Ø 66 mm 2 5/8"

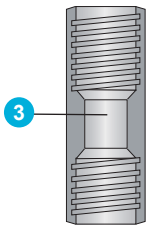
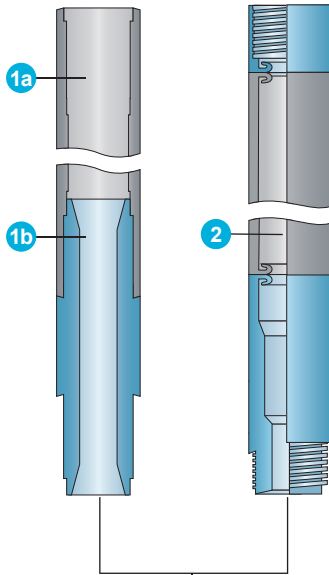

* Les tricônes existent aussi suivant code IADC D1/2/3

* Rockbits also exist according to code IADC D1/2/3

** Les tricônes existent aussi suivant code IADC T4/5/7

** Rockbits also exist according to code IADC T4/5/7





Forage Ø 64-66 mm Rotopercussion R32

Drilling Ø 64-66 mm Top Hammer R32



FORAGE PRESSIO PRESSIO DRILLING

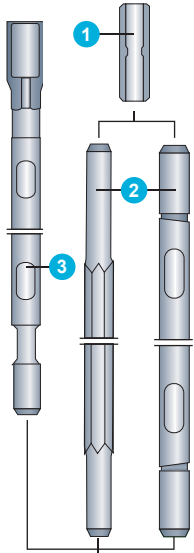

Description / Description	D		L		Poids / Weight	N° Article / Part No.		
	mm	ft in	mm	ft in				
1 Manchons / Couplings	R 32 - R 32		44	1 11/16"	150	6"	0.90	TOPCABDBDF150
2 Tiges allonges / Extension Rods	Rd 32 / Ø 11.7 mm				300		1.43	TOPCEPDPD0300
					500		2.70	TOPRKDPDP0500
					800		4.32	TOPRKDPDP0800
					915	3'	4.90	TOPRKDPDP0915
					1000		5.49	TOPRKDPDP1000
					1220	4'	6.70	TOPRKDPDP1220
					1500		8.10	TOPRKDPDP1500
					1525		8.20	TOPRKDPDP1525
					1830	6'	10.00	TOPRKDPDP1830
					2000		11.10	TOPRKDPDP2000
					2435	8'	14.00	TOPRKDPDP2435
				3050	10'	16.90	TOPRKDPDP3050	
				3660	12'	21.00	TOPRKDPDP3660	
3 MF-Tiges allonges / MF-Extension Rods	Rd 32 / Ø 11.7 mm				915	3'	5.30	TOPRKBDPD0915
					1220	4'	7.10	TOPRKBDPD1220
					1500	5'	8.80	TOPRKBDPD1500
					1525	5'	9.00	TOPRKBDPD1525
					1830	6'	10.50	TOPRKBDPD1830
					2435	8'	14.30	TOPRKBDPD2435
					3050	10'	18.00	TOPRKBDPD3050
4 Tiges de stabilisation / Stabilizing Rods			1000			3' 3 1/2"		STB0601000R32P0R32P1

5 BOUTONS RONDS / DOMED BUTTONS R 32 - 1 1/4"							
Diam.	Face	Corps / Body	Boutons / Buttons		Circulation / Flushing		N°Art / Part No.
			Centre	Gauge	Centre	Gauge	
60	S	Normal	3 - 10 mm	6 - 11 mm	3	-	TOPR0R32060SN
60	S	Rétro	3 - 10 mm	6 - 11 mm	3	-	TOPR0R32060SR
60	D	Rétro	3 - 10 mm	6 - 10 mm	3	-	TOPR0R32060DR
64	A	Normal	4 - 10 mm	8 - 10 mm	2	2	TOPR0R32064AN
64	A	Rétro	4 - 10 mm	8 - 10 mm	2	2	TOPR0R32064AR
64	D	Rétro	4 - 10 mm	6 - 11 mm	3	2	TOPR0R32064DR
66	A	Normal	4 - 10 mm	8 - 10 mm	2	2	TOPR0R32066AN
66	A	Rétro	4 - 10 mm	8 - 10 mm	2	2	TOPR0R32066AR
66	D	Rétro	4 - 9 mm	6 - 10 mm	3	-	TOPR0R32066DR

5 BOUTONS BALISTIQUES / BALLISTIC BUTTONS R 32 - 1 1/4"							
Diam.	Face	Corps / Body	Boutons / Buttons		Circulation / Flushing		N°Art / Part No.
			Centre	Gauge	Centre	Gauge	
60	S	Normal	3 - 10 mm	6 - 11 mm	3	-	TOPB0R32060SN
60	S	Rétro	3 - 10 mm	6 - 11 mm	3	-	TOPB0R32060SR
60	A	Rétro	4 - 9 mm	8 - 10 mm	2	2	TOPB0R32060AR
60	D	Rétro	4 - 9 mm	6 - 10 mm	3	-	TOPB0R32060DR
64	A	Normal	4 - 10 mm	8 - 10 mm	2	2	TOPB0R32064AN
64	A	Rétro	4 - 10 mm	8 - 10 mm	2	2	TOPB0R32064AR
64	D	Rétro	4 - 10 mm	6 - 11 mm	3	2	TOPB0R32064DR
66	A	Rétro	4 - 10 mm	8 - 10 mm	2	2	TOPB0R32066AR
66	D	Rétro	4 - 10 mm	6 - 10 mm	3	-	TOPB0R32066DR

6 OUTILS EN CROIX / CROSS BIT			
Diam. mm	Diam. in.	Corps / Body	N°Art / Part No.
60	2 1/8"	Normal	TOPH0R32060CN
60	2 1/8"	Rétro	TOPH0R32060CRPR
64	2 1/2"	Normal	TOPH0R32064CN
64	2 1/2"	Rétro	TOPH0R32064CRPR
66	2 19/32"	Normal	TOPH0R32066CN
66	2 19/32"	Rétro	TOPH0R32066CRPR

7 FORAGE ROTATIF - TAILLANTS BI-LÈVRES / ROTARY DRILLING - 2-WING BIT	
N° Article / Part No.	Description / Description
TOPH0R32060BL	R32 diamètre 60 mm taillant de rotation / 2-Wing Rotary Drill Bits Ø 60 mm
TOPH0R32064BL	R32 diamètre 64 mm taillant de rotation / 2-Wing Rotary Drill Bits Ø 64 mm
TOPH0R32066BL	R32 diamètre 66 mm taillant de rotation / 2-Wing Rotary Drill Bits Ø 66 mm

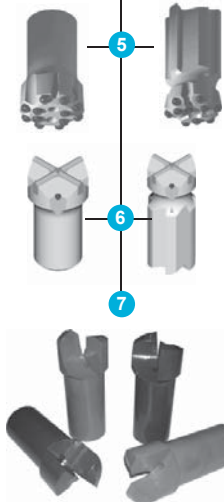

FORAGE PRESSIO PRESSIO DRILLING



Forage Ø 64-66 mm
Rotopercussion R38

Drilling Ø 64-66 mm Top Hammer R38

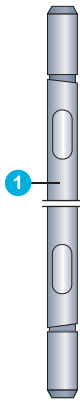

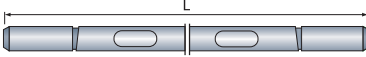
Description / Description	D		L		Poids / Weight	N° Article / Part No.
	mm	ft in	mm	ft in		
1 Tiges Allonges / Extension Rods 	Rd 39 / Ø 14.5 mm		500		3.90	TOPRLPFPF0500
			800		6.20	TOPRLPFPF0800
			915	3'	7.10	TOPRLPFPF0915
			1000		7.80	TOPRLPFPF1000
			1220	4'	9.50	TOPRLPFPF1220
			1500		11.70	TOPRLPFPF1500
			1525	5'	11.90	TOPRLPFPF1525
			1830	6'	15.00	TOPRLPFPF1830
			2000		15.60	TOPRLPFPF2000
			2435	8'	19.50	TOPRLPFPF2435
			3050	10'	24.00	TOPRLPFPF3050
		3660	12'	29.80	TOPRLPFPF3660	

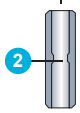

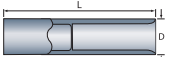
2 Manchons / Couplings 	R 38 - R 38	55	2 1/4"	170	6 1/16"	1.80	TOPCABFBFI170
---	-------------	----	--------	-----	---------	------	---------------

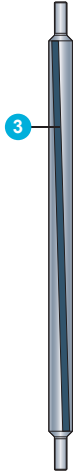

3 Tiges de stabilisation / Stabilizing Rods 				1000	3' 3 1/2"		STB0601000R38P0R38P1
--	--	--	--	------	-----------	--	----------------------

4 BOUTONS ROUNDS / DOMED BUTTONS R 38 - 1 1/2" DIAM. 60 MM

Diam.	Face	Corps / Body	Boutons / Buttons		Circulation / Flushing		N°Art / Part No.
			Centre	Gauge	Centre	Gauge	
60	A	Réto	4 - 10 mm	8 - 10 mm	2	2	TOPR0R38060AR
64	A	Normal	4 - 10 mm	8 - 10 mm	2	2	TOPR0R38064AN
64	A	Réto	4 - 10 mm	8 - 11 mm	2	2	TOPR0R38064AR
64	B	Réto	3 - 10 mm	6 - 12 mm	1	2	TOPR0R38064BR
64	D	Normal	4 - 10 mm	6 - 10 mm	3	2	TOPR0R38064DN
64	D	Réto	4 - 10 mm	6 - 10 mm	3	2	TOPR0R38064DR
66	A	Normal	4 - 10 mm	8 - 10 mm	2	2	TOPR0R38066AN
66	A	Réto	3 - 10 mm	6 - 10 mm	3	2	TOPR0R38066AR
66	D	Réto	4 - 10 mm	6 - 10 mm	3	2	TOPR0R38066DR

4 BOUTONS BALISTIQUES / BALLISTIC BUTTONS R 38 - 1 1/2"

Diam.	Face	Corps / Body	Boutons / Buttons		Circulation / Flushing		N°Art / Part Nr
			Centre	Gauge	Centre	Gauge	
60	A	Réto	4 - 9 mm	8 - 10 mm	2	2	TOPB0R38060AR
60	D	Réto	4 - 9 mm	6 - 10 mm	3	-	TOPB0R38060DR
64	A	Réto	4 - 10 mm	8 - 10 mm	2	2	TOPB0R38064AR
64	D	Réto	4 - 9 mm	6 - 10 mm	3	-	TOPB0R38064DR
66	A	Réto	4 - 10 mm	8 - 10 mm	2	2	TOPB0R38066AR
66	D	Réto	4 - 10 mm	6 - 10 mm	3	2	TOPB0R38066DR

5 OUTILS EN CROIX / CROSS BIT

Diam. mm	Diam. in.	Corps / Body	N°Art / Part Nr.
60	2 1/2"	Normal	TOPH0R38060CN
60	2 1/3"	Réto	TOPH0R38060CRPR
64	2 1/2"	Normal	TOPH0R38064CN
64	2 1/2"	Réto	TOPH0R38064CRPR
66	2 19/32"	Normal	TOPH0R38066CN
66	2 19/32"	Réto	TOPH0R38066CRPR

6 FORAGE DESTRUCTIF - TAILLANTS BI-LÈVRES / ROTARY DRILLING - 2-WING BIT

N°Article/PartNo.	Description / Description
TOPH0R38060BL	R38 diamètre 60 mm taillant de rotation / 2-Wing Rotary Drill Bits Ø 60 mm
TOPH0R38064BL	R38 diamètre 64 mm taillant de rotation / 2-Wing Rotary Drill Bits Ø 64 mm
TOPH0R38066BL	R38 diamètre 66 mm taillant de rotation / 2-Wing Rotary Drill Bits Ø 66 mm



Forage Ø 64-66 mm Marteau fond de trou Drilling Ø 64-66 mm Down the hole Hammer

FORAGE PRESSIO PRESSIO DRILLING

TYPE DE MARTEAU / HAMMER TYPE

Emmancement / Shank	Modèle / Model	Filetage / Top thread	Poids / Weight	N° Article / Part Number
HALCO	DOMINATOR 100	40 mm DIN 405 6TPI BOX	7 Kg	600422

DOMINATOR 1" SPECIFICATIONS / SPECIFICATIONS

1	Longueur hors tout sans l'outil / Make up Length without Bit	772 mm (30 3/8")
2	Diamètre extérieur / Outside Diameter	47 mm (1 7/8")
3	Poids du marteau / Hammer Weight	7 kg (15 lbs)
4	Filetage de tête / Top Thread	40 mm Droit DIN 405 6 filets par pouce Femelle 40 mm Right Hand DIN 405 6 TPI Box
6	Poussée maximum recommandée / Recommended maximum thrust	120 kg (264 lbs)

MARTEAU / HAMMER TYPE DOM 100

N° / Item	Description / Description	N° Article / Part Number
1	Protecteur de filetage / Thread Protector	200005
2	Anneau élastique / Snap Ring	783041
3	Siège du clapet anti-retour / N.R.V. Seat	603448
4	Joint torique / O Ring	768174
5	Clapet anti-retour / N.R.Valve	603447
6	Ressort du clapet anti-retour / N.R.V. Spring	760100
7	Adaptateur supérieur / Top-Adapter	603413
8	Joint torique / O Ring	768168
9	Joint torique / O Ring	768175
10	Cylindre / Cylinder	603410
11	Piston / Piston	603450
12	Anneau élastique / Snap Ring	783037

N° MODÈLE / MODEL NUMBER 600422

N° / Item	Description / Description	N° Article / Part Number
13	Anneau de retenue / Bit retaining ring	603449
14	Entretoise / Chuck Spacer	603412
15	Porte-outil / Chuck	603411
16	Bouchon de protection / Cap	741047
	Busette / Foot valve	603208
	Busette Outil - Corps / F/V tool - Body	603233
	Busette Outil - Pousoir / F/V tool - Pusher	603232
SK	Kit service / Service Kit	SK31
RK	Kit de réparation / Repair Kit	RK54

CLÉS / SPANNERS

Description / Description	N° Article / Part No.
Clé de démontage adaptateur supérieur / Spanners	603485

Une performance de pointe / Class leading performance

Un clapet anti-retour est monté dans le Dominator 100 pour améliorer ses performances lors de la présence d'eau. Cette valve peut être enlevée dans des trous secs pour obtenir une plus grande vitesse d'avancement.

A non-return valve is fitted into the Dominator 1" improving its performance in ground water conditions. This valve can be removed to increase the penetration rates in dry conditions.

Une gamme complète d'outils carburés / A full range of carburised drill bits

DOMINATOR 100 - HALCO SHANK

N° Article / Part Number	Ø mm / Inch	Ø mm / Inch	Profil /	Bouton / Button Type / Type	Qté / Ø Qty / Ø	Poids Kg / Weight Kg
650017	55	2 1/8"	FLAT	DOMED	6 x 11 mm / 2 x 9 mm	1,16
650032	64	2 1/2"	FLAT	DOMED	6 x 11 mm / 3 x 9 mm	1,37
653001	64	2 1/2"	FLAT	SEMI-BALL/BALLISTIC	6 x 11 mm SB / 3 x 9 mm B	1,37
653161	66	2 5/8"	FLAT	SEMI-BALL/BALLISTIC	6 x 11 mm SB / 3 x 9 mm B	1,37



Consommation d'air économique / Economical Air Consumption

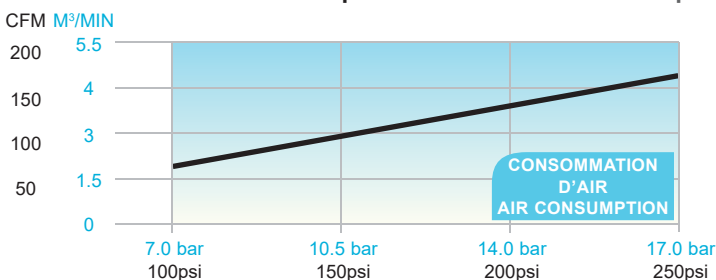

DOMINATOR 1"

Pression Pressure		Consommation d'air Air consumption	
PSI	BAR	CFM	M³/MIN
100	7	60	1.6
150	10.5	93	2.6
200	14	126	3.5
250	17	159	4.5



FORAGE PRESSIO PRESSIO DRILLING



Forage Ø 64-66 mm
Marteau fond de trou
Drilling Ø 64-66 mm
Down the hole Hammer

TYPE DE MARTEAU / HAMMER TYPE

Emmanchement / Shank	Modèle / Model	Filetage / Top thread	Poids / Weight	N° Article / Part Number
BR1	BR1	40 mm DIN 405 6TPI BOX	8 Kg	DTHBR1TOR

BR 1" SPECIFICATIONS / SPECIFICATIONS

Longueur hors tout sans l'outil / Make up Length without Bit	709 mm (27.9")
Diamètre extérieur / Outside Diameter	51 mm (2")
Poids du marteau / Hammer Weight	8 kg (17.6 lbs)
Filetage de tête / Top Thread	40 mm Droit DIN 405 6 filets par pouce Femelle 40 mm Right Hand DIN 405 6 TPI Box
Poussée maximum recommandée / Recommended maximum thrust	120 kg (264 lbs)

MARTEAU / HAMMER TYPE BR 1

N° / Item	Description / Description	N° Article / Part Number Marteau 1"
1	Cylindre extérieur / Wearsleeve	DTHBR1TOR-SP-1
2	Cylindre intérieur / Inner Cylinder	DTHBR1TOR-SP-2
3	Palier / Bearing	DTHBR1TOR-SP-3
4	Piston / Piston	DTHBR1TOR-SP-4
5	Bouchon réglage air / Air Metering Plug	DTHBR1TOR-SP-5
6	Boîtier de clapet anti-retour / Bevelled Valve Housing	DTHBR1TOR-SP-6
7	Centraliseur / Centraliser	DTHBR1TOR-SP-7
8	Disque de clapet anti-retour / Disc Valve	DTHBR1TOR-SP-8
9	Corps de clapet anti-retour / Valve Chest	DTHBR1TOR-SP-9
10	Raccord de tête / Backhead	DTHBR1TOR-SP-10
11	Joint / Backhead 'O' Ring	DTHBR1TOR-SP-11
12	Anneau de retenue / Bit Retaining Ring	DTHBR1TOR-SP-12
13	Rondelle / Backhead Spacer	DTHBR1TOR-SP-13
14	Porte-outil / Chuck	DTHBR1TOR-SP-14
15	Joint / Chuck Sealing Ring	DTHBR1TOR-SP-15
16	Clapet de retenue / Check Valve	DTHBR1TOR-SP-16
17	Ressort du clapet / Check Valve Spring	DTHBR1TOR-SP-17
18	Rondelle / Split Spacer	DTHBR1TOR-SP-18
	Kit service / Service Kit	DTHBR1TOR-SP-19
	Kit de réparation / Repair Kit	DTHBR1TOR-SP-20

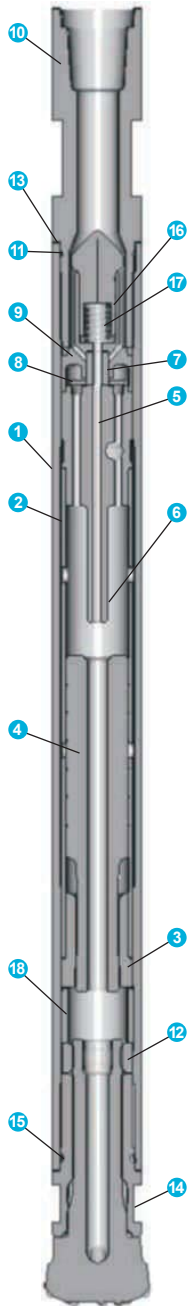

Une gamme complète d'outils carburisés / A full range of carburised drill bits

BR1 - BR1 SHANK

N° Article / Part Number	Ø mm / mm	Ø Inch / Inch	Profil / Profile	Bouton / Button Type / Type
DTH0BR01060FLBT	60	2 3/8"	FLAT	DOMED
DTH0BR01064FLBT	64	2 1/2"	FLAT	DOMED
DTH0BR01064FLSB	64	2 1/2"	FLAT	SEMI-BALL/BALLISTIC

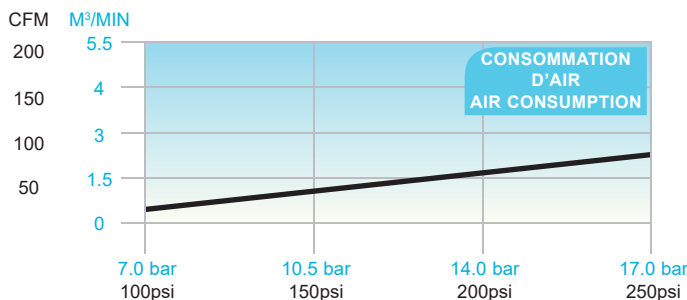
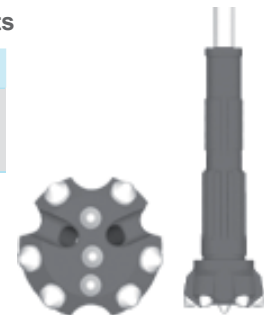

BR1 1"

Pression / Pressure		Consommation d'air / Air consumption	
PSI	BAR	CFM	M³/MIN
100	7	17.79	0.50
150	10.5	32.69	0.93
200	14	50.32	1.43
250	17	70.33	1.99





Carottier double Double Tube Core Barrel



CAROTTAGE CORING T2-66

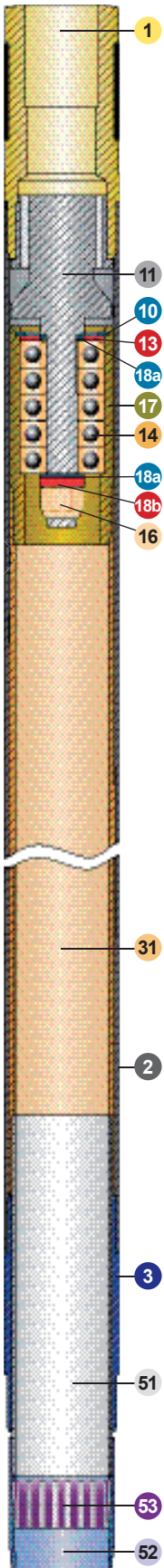

DONNÉES TECHNIQUES / TECHNICAL DATA

Diamètre du trou	66.50 mm	Hole Diameter	2.61 in
Diamètre de la carotte	51.70 mm	Core Diameter	2.04 in
Tube extérieur DE	65.20 mm	OD Outer Tube	2.57 in
Épaisseur de la couronne	7.20 mm	Bit Kerf	0.28 in
Surface de coupe	13.53 cm ²	Cutting Surface	2.10 in ²
Surface du trou	34.52 cm ²	Hole Area	5.35 in ²
Surface de la carotte	20.99 cm ²	Core Area	3.25 in ²
Ratio de surface en coupe par rapport au trou	39.00 %	Cutting Area as % of Hole Area	39.00 %
Filetage standard	CR 50	Standard Connexion	CR 50
Filetage optionnel	CR 60	Optional Thread	CR 60
Tiges recommandées	CR 50	Recommended Drill Rods	CR 50

PARAMÈTRES TYPIQUES DE FORAGE / TYPICAL DRILLING PARAMETERS

RPM Couronne imprégnée	850 - 1450	RPM Impregnated Bits
Poids sur l'outil	14 - 20 kN	Weight on bit
Débit de fluide	24 - 44 l/min	Flow rate
Vitesse d'avancement	9 - 18 cm/min	Penetration Rate

CAROTTIER COMPLET / COMPLETE CORE BARREL

		Long. hors tout avec couronne / Overall Length with Core Bit	N° / Item	N° Article / Part No.
STD	Carottier complet 3.00 m CR50 Fem	3.00 m Complete Core Barrel CR50 Box	1	53
	Carottier complet 1.50 m CR50 Fem	1.50 m Complete Core Barrel CR50 Box	1	53
	Carottier complet 1.00 m CR50 Fem	1.00 m Complete Core Barrel CR50 Box	1	53
	Tête complète de carottier CR50 Fem	Complete Core Barrel Head CR50 Box	1+10	18b
OPT	Carottier complet 3.00 m CR60 Fem	3.00 m Complete Core Barrel CR60 Box	1	53
	Carottier complet 1.50 m CR60 Fem	1.50 m Complete Core Barrel CR60 Box	1	53
	Carottier complet 1.00 m CR60 Fem	1.00 m Complete Core Barrel CR60 Box	1	53
	Tête complète de carottier CR60 Fem	Complete Core Barrel Head CR60 Box	1+10	18b

ASSEMBLAGE EXTÉRIEUR / OUTER ASSEMBLY

N° / Item	N° Article / Part No.	Pièces de Rechange Ass. Ext.	Spare Parts Outer Assembly	Qté / Qty
1	00T2066CRT0000C50B	Raccord de tête de carottier CR50 Fem	Corebarrel Coupling CR50 Box	1
1	00T2066CRT0000C60B	Raccord de tête de carottier CR60 Fem	Corebarrel Coupling CR60 Box	1
2	00T2066COT300	Tube extérieur Long. 3.0 m	Outer Tube Length 3.0 m	1
2	00T2066COT150	Tube extérieur Long. 1.5 m	Outer Tube Length 1.5 m	1
2	00T2066COT100	Tube extérieur Long. 1.0 m	Outer Tube Length 1.0 m	1
3	00T2066MATC00	Manchon aléuseur protégé carbure	TC Protected Reaming Shell	1

ASSEMBLAGE INTÉRIEUR / INNER ASSEMBLY

n° / Item	N° Article / Part No.	Pièces de Rechange Ass. Int.	Spare Parts Inner Assembly	Qté / Qty
10	CPSINT04700	Circlips	Stop Ring	1
11	00T2066CAC004	Axe	Bearing Shaft	1
13	RDL04670027100245	Rondelle	Washer	1
14	RLTE006303-2RS	Roulement étanche	Sealed Bearing	5
16	ENS00M160200	Ecrou Nylstop	Nut	1
17	00T2066CAC005	Bague porte roulement	Bearing Housing	1
18a	RDL02500017200100	Rondelle d'ajustage	Adjusting Washer	5
18b	RDL02490017000500	Rondelle d'ajustage	Adjusting Washer	1
31	00T2066CIT300	Tube intérieur Long. 3.0 m	Inner Tube Length 3.0 m	1
	00T2066CIT150	Tube intérieur Long. 1.5 m	Inner Tube Length 1.5 m	1
	00T2066CIT100	Tube intérieur Long. 1.0 m	Inner Tube Length 1.0 m	1

ASSEMBLAGE USUELLES / USUAL SPARE PARTS

n° / Item	N° Article / Part No.	Pièces de Rechange Usuelles	Spare Parts
51	00T2066CEXTUB	Tube d'extension	Extension Tube
52	00T2066CLIFCA	Porte ressort-extracteur	Core Lifter Case
53	00T2066CSTCOL	Ressort-extracteur standard	Standard Core Lifter
	00T2066CTICOL	Ressort-extracteur avec préserrage	Pre-gripping Core Lifter
	00T2066CBACOL	Ressort-extracteur à panier	Basket Core Lifter
	WRP06520	Clé Parmalee tube extérieur	Parmalee Full Grip Outer Tube
	WRP05700	Clé Parmalee tube intérieur	Parmalee Full Grip Inner Tube
	WRERIGID31025	Clé Ridgid	Ridgid Wrench
	00T2066CHACAR0100G	Chasse carotte x 1" Gaz	Core Ejector x 1"



BATTAGE BEATING STS-63

Carottier échantillonneur par battage Solid Tube Sampler

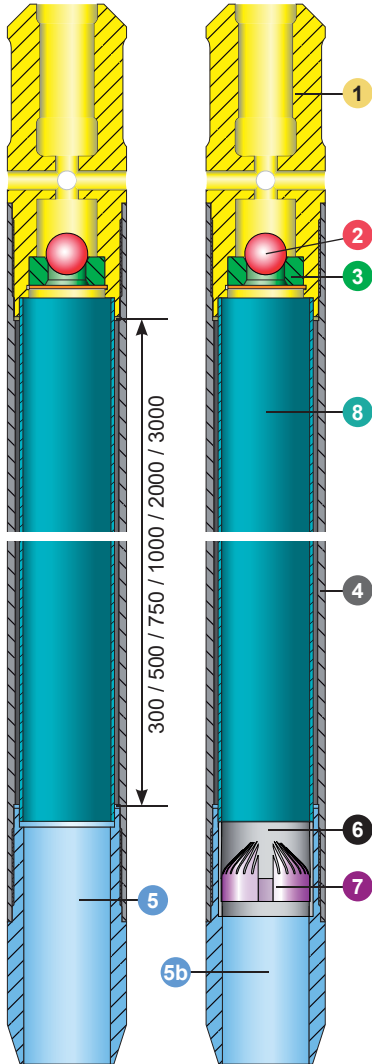

0STS063CBC

0STS063CBB

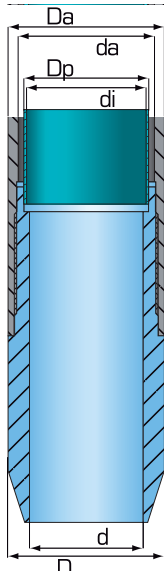

STS-63 X R32 FEM GAUCHE / LH BOX

N° / Item	N° Article / Part No.	Description / Description
1 → 5	0STS063CBC0300R32B	Carottier complet sans panier / Corebarrel Assy without Basket - Lg 0.30 m
1 → 5	0STS063CBC0500R32B	Carottier complet sans panier / Corebarrel Assy without Basket - Lg 0.50 m
1 → 5	0STS063CBC0750R32B	Carottier complet sans panier / Corebarrel Assy without Basket - Lg 0.75 m
1 → 5	0STS063CBC1000R32B	Carottier complet sans panier / Corebarrel Assy without Basket - Lg 1.00 m
1 → 5	0STS063CBC2000R32B	Carottier complet sans panier / Corebarrel Assy without Basket - Lg 2.00 m
1 → 7	0STS063CBB0300R32B	Carottier complet avec panier / Corebarrel Assy with Basket - Lg 0.30 m
1 → 7	0STS063CBB0500R32B	Carottier complet avec panier / Corebarrel Assy with Basket - Lg 0.50 m
1 → 7	0STS063CBB0750R32B	Carottier complet avec panier / Corebarrel Assy with Basket - Lg 0.75 m
1 → 7	0STS063CBB1000R32B	Carottier complet avec panier / Corebarrel Assy with Basket - Lg 1.00 m
1 → 7	0STS063CBB2000R32B	Carottier complet avec panier / Corebarrel Assy with Basket - Lg 2.00 m
1 → 3	0STS063CBHEAD0R32B	Tête x filetage R32 gauche / Head x Thread R32 LH
4	0STS063COT030LH	Tube acier à gauche / Steel Tube Left Thread - 0.30 m
4	0STS063COT050LH	Tube acier à gauche / Steel Tube Left Thread - 0.50 m
4	0STS063COT075LH	Tube acier à gauche / Steel Tube Left Thread - 0.75 m
4	0STS063COT100LH	Tube acier à gauche / Steel Tube Left Thread - 1.00 m
4	0STS063COT200LH	Tube acier à gauche / Steel Tube Left Thread - 2.00 m
4	0STS063COT300LH	Tube acier à gauche / Steel Tube Left Thread - 3.00 m
5	0STS063CTROCP LH	Trousse simple à gauche / Standard Shoe Left Thread
5b	0STS063CRTBCPLH	Trousse pour panier à gauche / Basket Shoe Left Thread
6	0STS063CBAENT	Entretoise pour panier / Basket Washer
7	0STS063CBACOL	Panier / Basket
8	TUPE0490004700030	Tube PE / PE Liner - Ø 49.00 x Ø 47.00 x 0.30 m
8	TUPE0490004700050	Tube PE / PE Liner - Ø 49.00 x Ø 47.00 x 0.50 m
8	TUPE0490004700075	Tube PE / PE Liner - Ø 49.00 x Ø 47.00 x 0.75 m
8	TUPE0490004700100	Tube PE / PE Liner - Ø 49.00 x Ø 47.00 x 1.00 m
8	TUPE0490004700200	Tube PE / PE Liner - Ø 49.00 x Ø 47.00 x 2.00 m
8	TUPE0490004700300	Tube PE / PE Liner - Ø 49.00 x Ø 47.00 x 3.00 m

Ce carottier peut être équipé de tubes PVC que l'on peut trouver dans le commerce. Cependant, DATC vous conseille l'emploi de tubes polyéthylène translucides.

This core barrel can be fitted with PVC tubes that can be found in stores. However, DATC recommends using Polyethylene liners.

Dimensions

Tube Acier / Steel Tube	Diam. Ext. / OD	Da	63.00
	Diam. Int. / ID	da	55.00
Gaine translucide / PE Liner	Diam. Ext. / OD	Dp	49.00
	Diam. Int. / ID	di	47.00
Sabot / Shoe	Diam. Ext. / OD	D	63.00
	Diam. Int. / ID	d	46.00
Filetage de tête / Head Connection		Fem / Box	R32

Terrains prélevés / Ground Formation
0.50-1.50 MPa



En option (nous consulter) :

DATC propose une gamme de tubes extérieurs STS63 avec des lumières pour un prélèvement de l'échantillon à la cuillère. Suivant la longueur de cet échantillon, le tube se décline en 2, 3 ou 4 lumières.

Options (consult us):

DATC also manufactures STS63 outer tubes with windows for easy removal of the sample. According to the sample length, the outer tube will have 2, 3 or 4 windows.

N° Article / Part No.	Description / Description
0STS063COT100LH2LUM	Tube acier 1.00 m à gauche avec 2 lumières / 1.00 m Steel Tube Left Thread with 2 Windows
0STS063COT200LH3LUM	Tube acier 2.00 m à gauche avec 3 lumières / 2.00 m Steel Tube Left Thread with 3 Windows
0STS063COT200LH4LUM	Tube acier 2.00 m à gauche avec 4 lumières / 2.00 m Steel Tube Left Thread with 4 Windows





Forage par méthode de tubage à l'avancement

Overburden Drilling Method

FORAGE PRESSIO PRESSIO DRILLING

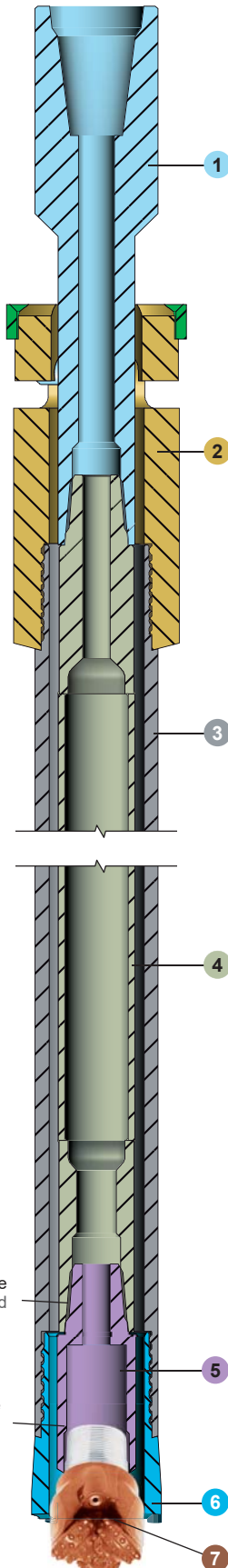

Sur certains de vos chantiers de pressiométrie, la configuration du terrain peut contraindre à tubage les premiers mètres du forage pressiométrique afin de réaliser les essais en-deçà d'un niveau non-stabilisé. DATC vous propose alors un système de tubage à l'avancement clé-en-main afin d'insérer par rotation (entraînement tête baïonnette) un train de tubage muni d'une couronne au travers duquel un taillant (tricône, trilame ou autre) permettra de réaliser le trou de sondage dans un diamètre respectant la NF P 94-110-1.

Some pressiometric drilling fields will require tubing through the first few meters of unstable ground in order to reach the testing depths. DATC can supply a versatile overburden drilling solution to this problem. A tube string, driven via a bayonet head and with a core bit at the bottom, is inserted by rotation. A cutting bit (rockbit, dragbit, etc.) passes through this, making a sampling hole of standard diameter corresponding to NF P 94-110-1.

NOMENCLATURE / NOMENCLATURE

N° / Item	N° Article / Part No.	Description / Description
1	BAY238RB0BWJBRH-1	Baïonnette 2 3/8" API Reg Fem x BWJ Fem 2 3/8" bayonet API Reg box x BWJ box
2	BAYR089BRH-1	Tête d'entraînement OD88.9 cylindrique droite 1 entrée Drive Head OD88.9 straight cylindrical 1-entry
3	R2L089069150TT	Tubage OD88.9 cylindrique droite 1 entrée, 1.50 m OD88.9 cylindrical tube, straight 1-entry, 1.50 m
4	RODFBWJRH150M	Tige BWJ 1.50 m BWJ Rod 1.50 m
5	RE7NRODBE50BWJP080	Raccord BWJ Male x NROD Femelle Lg utile 80 mm Coupling BWJ pin x NROD box, make-up length 80 mm
6	R2L095069089PT	Couronne à prismes Ø95 OD88.9 cylindrique droite 1 entrée Prismatic crown bit, ext. diam 95 OD88.9 cylindrical 1-entry RH
7	RBTCXT5020102NRODP	Trilcone type T5 2 1/2" filetage NROD T5 type 2 1/2" rock bit NROD thread

Le choix de ces éléments est à modifier en fonction des besoins et du matériel de forage: Variable options are available depending on specific drilling needs:

- 1 Dépend du filetage machine, donc le filetage supérieur de la baïonnette peut varier.
Depends on thread at machine: the upper thread of the bayonet can vary.
- 3 Des variantes en tube nipples soudés (TW) ou nipples vissés (TC) sont disponibles sur demande.
Variants with welded nipples (TW) and screwed nipples (TC) are available on demand.
- 7 Peut être remplacé par un tricône ou autre trépan.
Can be a rockbit, drag bit or other non-coring bit.
- 5 Dépend directement de 7 et du dépassement optimal de 7 par rapport à 6.
Choice of coupling 5 depends on bit 7 and ideal protrusion beyond 6.



TARIÈRES & SONDES À EAU

AUGERS & WATER INDICATOR

Tarières à main
Hand Augers

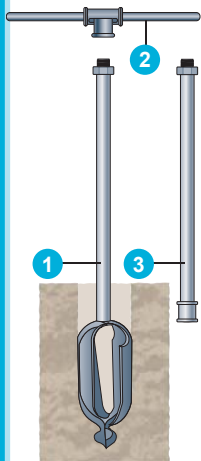

SÉRIE STANDARD 3/4" / STANDARD SERIES 3/4"					
Diamètre Diameter	Tarière complète avec tourne à gauche Complete Auger with Cross Handle	Tarière Auger	Tourne à gauche Cross Handle	Tige allonge 0.5 m Extension Rod 0.5 m	Tige allonge 1 m Extension Rod 1 m
	1 2	1	2	3	3
63 mm	AUH063CPL100	AUH063TAR100	AUH000TARMAN	AUH002EXT050	AUH002EXT100
80 mm	AUH080CPL100	AUH080TAR100	AUH000TARMAN	AUH002EXT050	AUH002EXT100
90 mm	AUH090CPL100	AUH090TAR100	AUH000TARMAN	AUH002EXT050	AUH002EXT100
100 mm	AUH100CPL100	AUH100TAR100	AUH000TARMAN	AUH002EXT050	AUH002EXT100
125 mm	AUH125CPL100	AUH125TAR100	AUH000TARMAN	AUH002EXT050	AUH002EXT100
150 mm	AUH150CPL100	AUH150TAR100	AUH000TARMAN	AUH002EXT050	AUH002EXT100

Tous les filetages de connexion des éléments sont 3/4" Gaz à droite.
All connecting threads are 3/4" Gas RH.

Sondes de niveau d'eau Lumineuses et sonores

Water Level Indicators - Light and Sound

Les sondes à eau DATC mesurent le niveau d'eau dans le forage. C'est un instrument portable et alimenté par une batterie, qui est constitué d'un câble isolé et résistant enroulé sur un dévidoir. Le bout du câble est équipé d'une sonde qui agit comme un interrupteur et active un signal sonore et lumineux lorsqu'elle entre en contact avec l'eau.

Lorsque l'alarme est activée, la position de la sonde est lue directement sur le câble gradué et représente le niveau d'eau dans le forage.

DATC water level indicators measure water tables in the borehole. It is a portable and battery powered instrument which consists of a stretch-resistant insulated cable on a reel. The cable end is fitted with a dipping probe which acts as a switch and activates an audible alarm and a light indicator when in contact with water.

The probe's alarm position represents the water level depth and is read directly from the graduated cable.

CARACTÉRISTIQUES TECHNIQUES / SPECIFICATIONS

Ruban de mesure : Ruban en polyéthylène à 2 conducteurs en acier
Chiffres des mètres en rouge, dm en noir, division en cm en noir, sur fond blanc

Sonde : Acier inoxydable / laiton nickelé
Ø 15 mm, longueur 190 mm

Tambour : Matière synthétique très solide ; résistante au froid

Armature : Fonte d'aluminium ; à revêtement synthétique

Alimentation : 4 piles alcalines 1.5 V, type LR14 C AM 2

Température de travail : - 30°C à + 75°C

Mesure de niveau d'eau (profondeur)

Etendue de mesure : 15, 25, 30, 50, 80, 100, 150, 200, 250, 300, 500 et 750m

Mesure de la temp. : KL 010 TM

Affichage : A cristaux liquides, 3 1/2 digit
Résolution 0.1°C

Test automatique de tension des piles

Etendue de mesure : - 5°C à + 60°C

Précision : ± 0.1°C

Measuring Tape : Polyethylene tape (two wires)
Meter graduation in red, decimeters in black, cm marks graduation in black on white tape

Probe : Stainless Steel / Brass Galvanized
0.6" (15 mm) dia., 6.9" (175 mm) long

Cable drum : Robust special drum

Frame : Alu Cast, Plastic Coated

Operating Power : 4 x 1.5 V Batteries, type LR14 C AM 2

Operating Temperature : - 30 °C to + 75 °C

Measuring Water Level (Depth)

Measuring Range : 15, 25, 30, 50, 80, 100, 150, 200, 250, 300, 500 and 750m

Temp. Measurement : KL 010 TM

Display : LCD - 3 1/2 digits
Resolution 0.1°C

Automatic Battery Checking Device

Measuring range temp. : - 5°C to + 60°C

Accuracy : ± 0,1°C

N° Art. / Part No.	Description / Description
SONEAU015CMCP	Sonde de niveau - 15 m série compacte / Dipmeter - 15 m Compact Serie
SONEAU025CMCP	Sonde de niveau - 25 m série compacte / Dipmeter - 25 m Compact Serie
SONEAU025CM	Sonde de niveau - 25 m / Dipmeter - 25 m
SONEAU050CM	Sonde de niveau - 50 m / Dipmeter - 50 m
SONEAU100CM	Sonde de niveau - 100 m / Dipmeter - 100 m
SONEAU150CM	Sonde de niveau - 150 m / Dipmeter - 150 m
SONEAU250CM	Sonde de niveau - 250 m / Dipmeter - 250 m
SONEAU300CM	Sonde de niveau - 300 m / Dipmeter - 300 m
SONEAU001	Option détection de fond pour sonde KL010 / Option Background Detection for KL010 Probe
SONEAU002	Bouchon pour logement piles Série KL010 / Cap for Batteries Housing

